



**2024**

**APEQ WIWA**  
STRAAL- & VERFSPUITAPPARATUUR

**Elektrische Membranpumpen**

*Electric diaphragm pumps*

12 - 17



**Airless Spritzpistolen & Zubehör**

*Airless spray guns & accessories*

48 - 59

**Elektrische Kolbenpumpen**

*Electric piston pumps*

18 - 31



**Rohrinnenbeschichtung**

*Inner tube guns*

60 - 61

**Pneumatische Kolbenpumpen**

*Pneumatic piston pumps*

32 - 33



**AirCombi Spritzpistolen**

*AirCombi spray guns*

62 - 65

**HVLP**

*Turbine sprayer*

34 - 35



**Airless & AirCombi Düsensysteme**

*Airless & AirCombi tip systems*

66 - 87

**Pumpen Zubehör & Ansaugsysteme**

*Pump accessories & suction systems*

36 - 43



**Filtersysteme**

*Filter systems*

88 - 99

**Elektrische Mixer & Flächenspachtel**

*Electric mixer & smoothing blades*

44 - 45



**Farbspritzschläuche & Heizschläuche**

*Paint spray hoses & heated hoses*

100 - 107

**Bautenschutz**

*Building protection*

46 - 47



**Reinigen & All-In Kits**

*Cleaning & All-In kits*

108 - 119

**PRONA**  
Drucktanks / Pressure pots  
122 - 125



**ASM**  
142 - 145

**PRONA**  
Doppelmembranpumpen / Double diaphragm pumps  
126 - 127



**GRACO CED**  
146 - 149

**PRONA**  
Pneumatische Rührwerke / Pneumatic agitators  
128 - 131



**GRACO Heavy Duty**  
150 - 151

**PRONA**  
Luftpistolen / Air guns  
132 - 135



**GRACO Finishing**  
152 - 155

**PRONA**  
Automatik Pistolen / Automatic guns  
136 - 137



**WAGNER**  
156 - 157

**AIRGUNSA & ANEST IWATA**  
Luftpistolen / Air guns  
138 - 139



**WIWA & KREMLIN**  
158 - 159

**Niederdruck Zubehör**  
Low pressure accessories  
140 - 141



**FORMECO**  
160 - 161

# ELECTRIC DIAPHRAGM PUMP SERIES

## MA-A4000

T 0.021" | 4 ltr./min. | 22 kg



Art.-Nr. / Part-No.  
**MA-A4000**

**MASPRA Airless Pumpe A4000 auf Tragegestell**

- 6 Liter Oberbehälter mit Filter
- Rücklauf

**MASPRA Airless pump A4000 on frame**

- 6 liter hopper with filter
- Return pipe



Art.-Nr. / Part-No.  
**MA-A4000-AL**

**MASPRA A4000 SprayPack:**

- Oberbehälter: 6 Liter
- Schlauch: 3/16" - 7.5 m - 1/4" NPS
- Pistole: 500 bar - 3 mm Kugel
- Filter: gelb
- Düse & Halter: Maspra - 415

- Hopper: 30 liters
- Hose: 3/16" - 7.5 m - 1/4" NPS
- Gun: 500 bar - 3 mm ball
- Filter: yellow
- Tip & base: MASPRA - 415



# ELECTRIC DIAPHRAGM PUMP SERIES

## MA-A5000

⚡ 0.025" | 5 ltr./min. | 29 kg



Art.-Nr. / Part-No.  
**MA-A5000**

MASPRA Airless Pumpe  
A5000 auf Fahrwagen  
inklusive Manometer-  
Kombination

MASPRA Airless pump  
A5000 on trolley  
including gauge set



Art.-Nr. / Part-No.  
**MA-A5000-AL1**

MASPRA A5000 SprayPack:

- Oberbehälter: 30 Liter
- Schlauch: 1/4" - 15 m - 1/4" NPS
- Pistole: 500 bar - 3 mm Kugel
- Filter: weiß
- Düse & Halter: Maspra - 421

- Hopper: 30 liters
- Hose: 1/4" - 15 m - 1/4" NPS
- Gun: 500 bar - 3 mm ball
- Filter: white
- Tip & base: MASPRA - 421



Art.-Nr. / Part-No.  
**MA-A5000-AL2**

MASPRA A5000 SprayPack:

- Flexibles Ansaugsystem: NW19
- Schlauch: 1/4" - 15 m - 1/4" NPS
- Pistole: 500 bar - 3 mm Kugel
- Filter: weiß
- Düse & Halter: Maspra - 421

- Flexible suction system: NW19
- Hose: 1/4" - 15 m - 1/4" NPS
- Gun: 500 bar - 3 mm ball
- Filter: white
- Tip & base: MASPRA - 421



# ELECTRIC DIAPHRAGM PUMP SERIES

## MA-A10000

T 0.041" | 9 ltr./min. | 46 kg

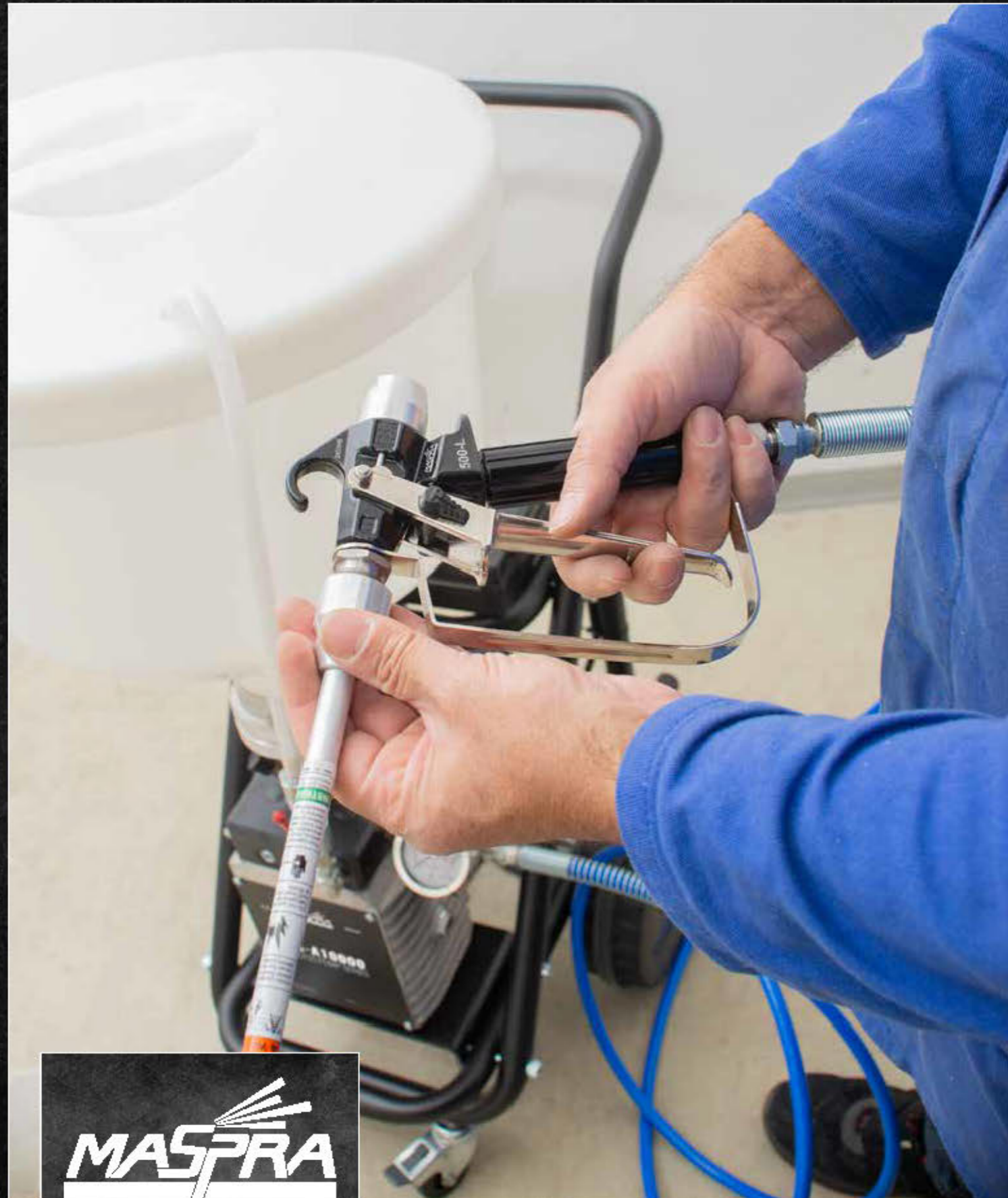

Art.-Nr. / Part-No.  
**MA-A10000**

MASPRA Airless Pumpe  
A10000 auf Fahrwagen  
inklusive Manometer-  
Kombination

MASPRA Airless pump  
A10000 on trolley  
including gauge set



Art.-Nr. / Part-No.  
**MA-A10000-AL1**

**MASPRA A10000 SprayPack:**

- Oberbehälter: 30 Liter
- Schlauch: 1/4" - 15 m - 1/4" NPS
- Pistole: 500 bar - 5 mm Kugel
- Filter: weiß
- Düse & Halter: Maspra - 427

- Hopper: 30 liters
- Hose: 1/4" - 15 m - 1/4" NPS
- Gun: 500 bar - 5 mm ball
- Filter: white
- Tip & base: MASPRA - 427



Art.-Nr. / Part-No.  
**MA-A10000-AL2**

**MASPRA A10000 SprayPack:**

- Flexibles Ansaugsystem: NW25
- Schlauch: 1/4" - 15 m - 1/4" NPS
- Pistole: 500 bar - 5 mm Kugel
- Filter: weiß
- Düse & Halter: Maspra - 427

- Flexible suction system: NW25
- Hose: 1/4" - 15 m - 1/4" NPS
- Gun: 500 bar - 5 mm ball
- Filter: white
- Tip & base: MASPRA - 427



MADE IN EUROPE

# ELECTRIC PISTON PUMP SERIES

## MA-EP19G

T 0.019" | 1.5 ltr./min. | 8 kg



Art.-Nr. / Part-No.  
**MA-EP-19**

MASPRA Airless Pumpe  
EP19 auf Tragegestell  
inklusive flexiblem  
Ansaugsystem

MASPRA Airless pump  
EP19 on frame  
including flexible suction  
system



Art.-Nr. / Part-No.  
**MA-EP-19-SET**

MASPRA EP19 SprayPack:

- Flexibles Ansaugsystem
- Schlauch: 3/16" - 7.5 m - 1/4" NPS
- Pistole: 250 bar - 3 mm Kugel
- Filter: weiß
- Düse & Halter: MASPRA - 517
- Flexible suction system
- Hose: 3/16" - 7.5 m - 1/4" NPS
- Gun: 250 bar - 3 mm ball
- Filter: white
- Tip & base: MASPRA - 517



Art.-Nr. / Part-No.  
**MA-EP-19-HOP**

MASPRA Airless Pumpe  
EP19 auf Tragegestell  
inklusive 5 Ltr. Oberbehälter

MASPRA Airless pump  
EP19 on frame  
including 5 ltr. hopper



Art.-Nr. / Part-No.  
**MA-EP-19-CART**

MASPRA Airless Pumpe  
EP19 auf Fahrwagen  
inklusive flexibles  
Ansaugsystem

MASPRA Airless pump  
EP19 on trolley  
including flexible suction  
system



Art.-Nr. / Part-No.  
**MA-EP-19-HOP-SET**

**MASPRA EP19 SprayPack:**

- 5 Ltr. Oberbehälter
- Schlauch: 3/16" - 7.5 m - 1/4" NPS
- Pistole: 250 bar - 3 mm Kugel
- Filter: weiß
- Düse & Halter: MASPRA - 517

- 5 ltr. Oberbehälter
- Hose: 3/16" - 7.5 m - 1/4" NPS
- Gun: 250 bar - 3 mm ball
- Filter: white
- Tip & base: MASPRA - 517



Art.-Nr. / Part-No.  
**MA-EP-19-CART-SET**

**MASPRA EP19 SprayPack:**

- Flexibles Ansaugsystem
- Schlauch: 3/16" - 7.5 m - 1/4" NPS
- Pistole: 250 bar - 3 mm Kugel
- Filter: weiß
- Düse & Halter: MASPRA - 517

- Flexible suction system
- Hose: 3/16" - 7.5 m - 1/4" NPS
- Gun: 250 bar - 3 mm ball
- Filter: white
- Tip & base: MASPRA - 517





# ELECTRIC PISTON PUMP SERIES

## MA-EP21G

T 0.021" | 2.0 ltr./min. | 15 kg

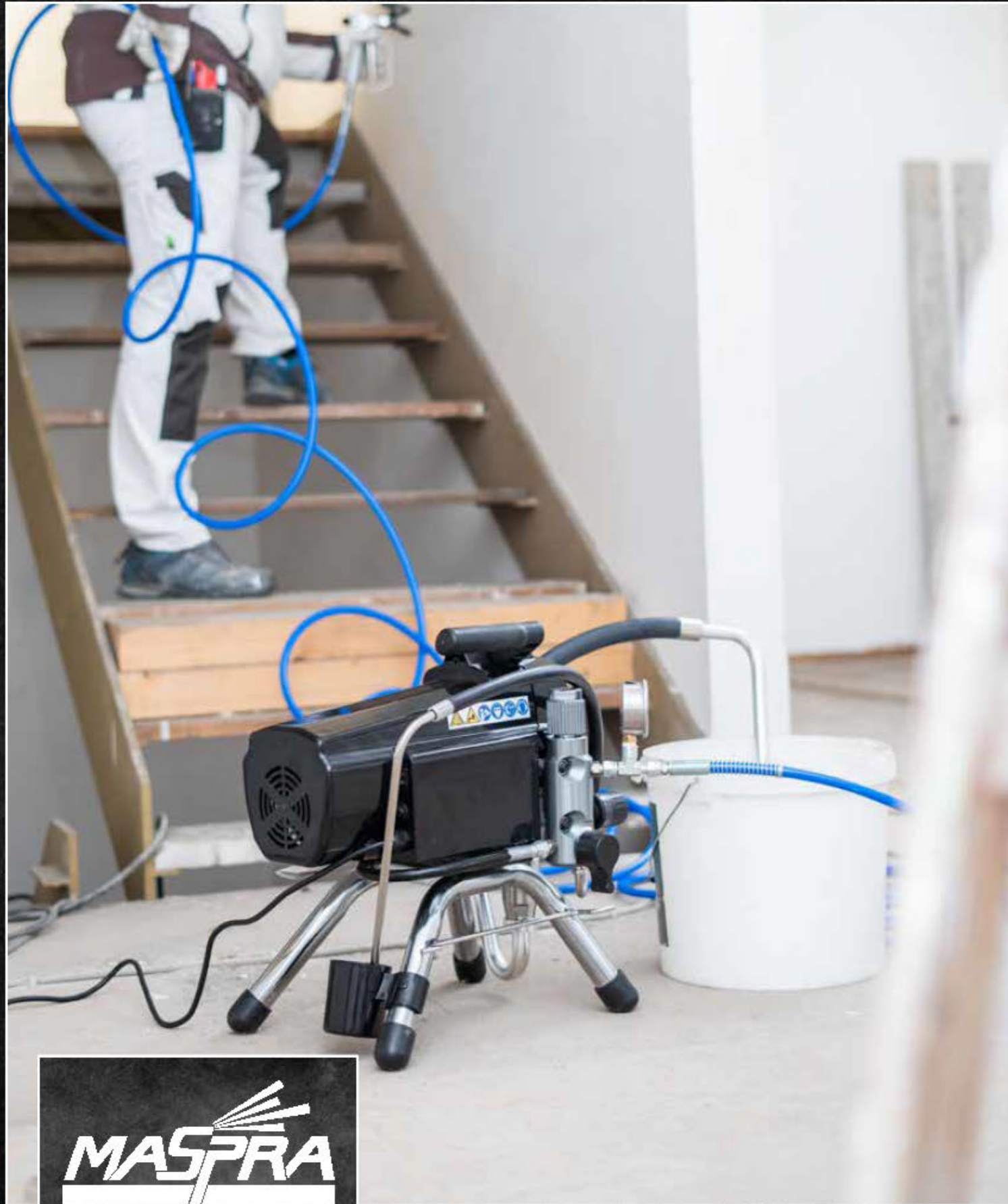

Art.-Nr. / Part-No.  
**MA-EP-21-G**

MASPRA Airless Pumpe  
EP21 auf Tragegestell  
inklusive flexiblem  
Ansaugsystem

MASPRA Airless pump  
EP21 on frame  
including flexible suction  
system

Art.-Nr. / Part-No.  
**MA-EP-21-G-SET**

MASPRA EP21 SprayPack:

- Flexibles Ansaugsystem
- Schlauch: 1/4" - 15 m - 1/4" NPS
- Pistole: 250 bar - 3 mm Kugel
- Düse & Halter: MASPRA - 311 & 517
- Flexible suction system
- Hose: 1/4" - 15 m - 1/4" NPS
- Gun: 250 bar - 3 mm ball
- Tip & base: MASPRA - 311 & 517



# ELECTRIC PISTON PUMP SERIES

## MA-EP29G

T 0.029" | 3.2 ltr./min. | 32 kg

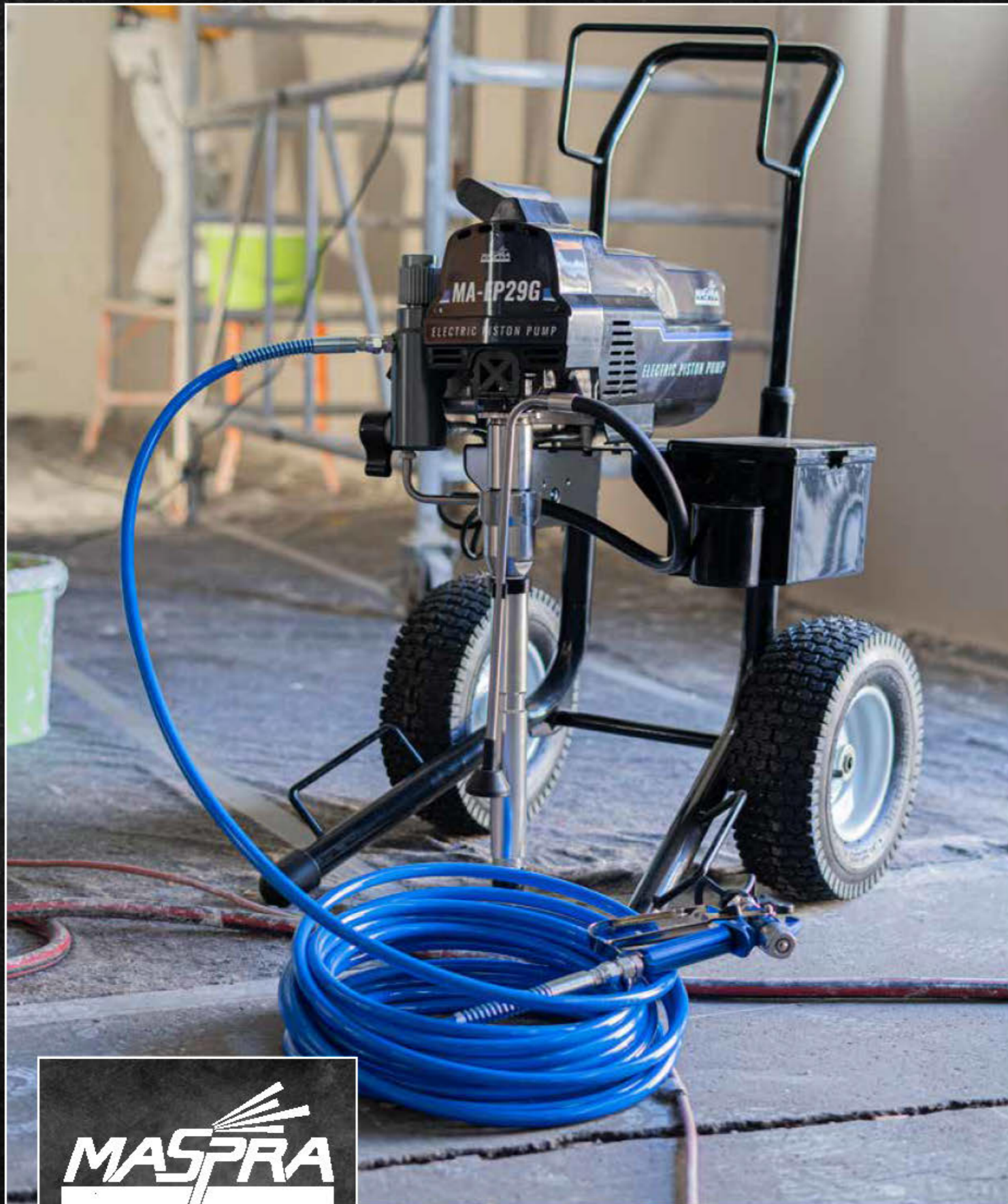

Art.-Nr. / Part-No.  
**MA-EP-29-G**

MASPRA Airless Pumpe  
EP29 auf Fahrwagen  
inklusive Ansaugsystem

MASPRA Airless pump  
EP29 on trolley  
including suction system

Art.-Nr. / Part-No.  
**MA-EP-29-G-SET**

MASPRA EP29 SprayPack:

- Schlauch: 1/4" - 15 m - 1/4" NPS
- Pistole: 500 bar - 3 mm Kugel
- Düse & Halter: MASPRA - 517

- Hose: 1/4" - 15 m - 1/4" NPS
- Gun: 500 bar - 3 mm ball
- Tip & base: MASPRA - 517



OPTION  
PRIVATE LABEL



# ELECTRIC PISTON PUMP SERIES

## MA-EP37G

T 0.037" | 5.0 ltr./min. | 57 kg

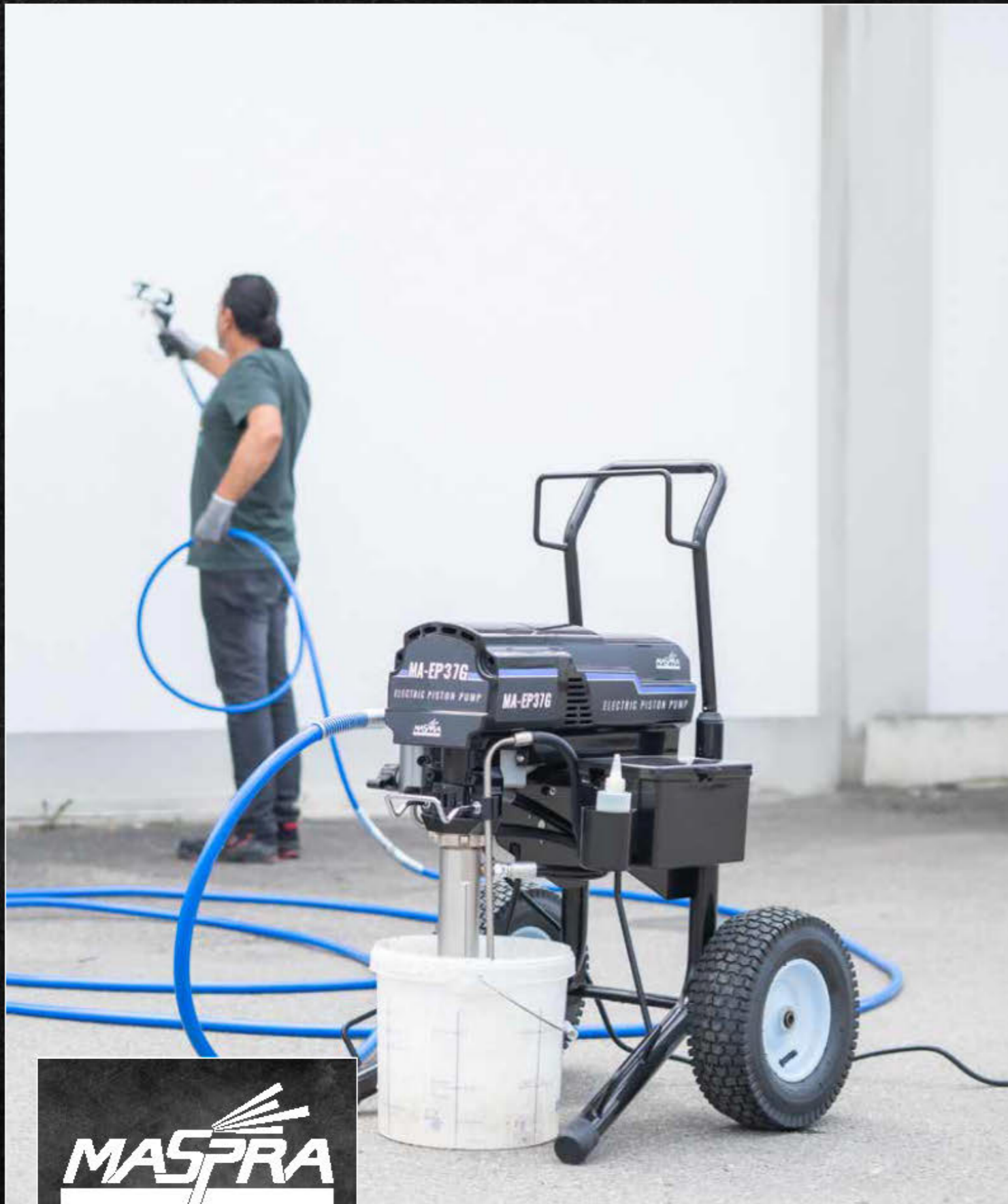

Art.-Nr. / Part-No.  
**MA-EP-37-G**

MASPRA Airless Pumpe  
EP37 auf Fahrwagen  
inklusive Ansaugsystem

MASPRA Airless pump  
EP37 on trolley  
including suction system

Art.-Nr. / Part-No.  
**MA-EP-37-G-SET**

MASPRA EP37 SprayPack:

- Schlauch: 3/8" - 15 m - 3/8" NPS
- Schlauchpeitsche: 1/4" - 1.5 m
- Pistole: 500 bar - 5 mm Kugel
- Düse & Halter: MASPRA - 517 & 535

- Hose: 3/8" - 15 m - 3/8" NPS
- Hose whip: 1/4" - 1.5 m
- Gun: 500 bar - 5 mm ball
- Tip & base: MASPRA - 517 & 535



# ELECTRIC PISTON PUMP SERIES

## MA-EP45G

T 0.045" | 8.0 ltr./min. | 52 kg



Art.-Nr. / Part-No.  
**MA-EP-45-G**

MASPRA Airless Pumpe  
EP45 auf Fahrwagen  
inklusive Ansaugsystem

MASPRA Airless pump  
EP45 on trolley  
including suction system

Art.-Nr. / Part-No.  
**MA-EP-45-G-SET**

MASPRA EP45 SprayPack:

- 2x Schlauch: 1/2" - 15 m - 1/2" NPS
- Schlauchpeitsche: 3/8" - 3.5 m
- Pistole: 250 bar - 5 mm Kugel
- Düse & Halter: MASPRA - 531 & 541
- Düsen- und Bürstenreinigung

- 2x Hoses: 1/2" - 15 m - 1/2" NPS
- Hose whip: 3/8" - 3.5 m
- Gun: 250 bar - 5 mm ball
- Tip & base: MASPRA - 531 & 541
- Tip and brush cleaning



# GRAVITY FEED HOPPER



Art.-Nr. / Part-No.  
**MA-EP-HOP-60**

- MASPRA Großmengen-  
behälter**
- 60 Liter
  - Für Farbe und Spachtel
  - Inklusive Sackpresse und Deckel
  - Optional mit Rüttler

- MASPRA gravity feed  
hopper**
- 60 liter
  - For paints and plasters
  - Including bag press and cover
  - Optional with shaker



**Rüttler / Shaker**



**OPTIONAL**

Aufpreis / surcharge  
100,- €

Art.-Nr. / Part-No.  
**UNI-REEL-3/8-1.5**

- MASPRA Universal  
Schlauchaufroller**
- 3/8" NPS
  - Inkl. 1.5 m Verbindungsschlauch

- MASPRA Universal  
hose reel**
- 3/8" NPS
  - Including 1.5 m hose connection

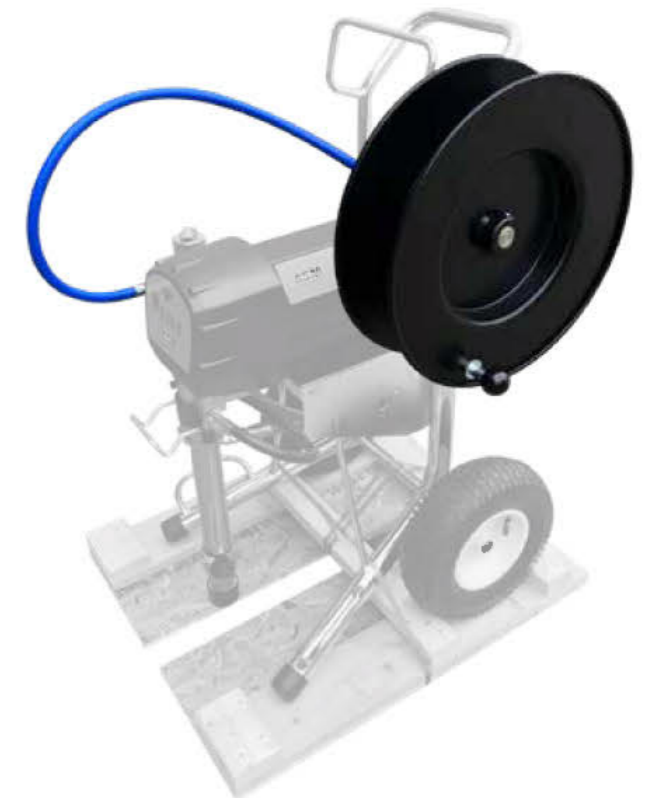

# PNEUMATIC PISTON PUMP SERIES

## MA-QUEEN-68

68:1 | 180 ccm | 2.9 ltr./min.



Art.-Nr. / Part-No.  
**MA-Q-68**

MASPRA Airless Pumpe  
QUEEN-68 auf Fahrwagen  
inklusive Ansaugschlauch

MASPRA Airless pump  
QUEEN-68 on trolley  
including suction hose



Art.-Nr. / Part-No.  
**MA-Q-68-SET**

MASPRA QUEEN-68 SprayPack

- Inkl. Ansaugschlauch
- Schlauch: 3/8" - 15 m - 500 bar
- Schlauchpeitsche: 1/4" - 1.8 m
- Pistole: 500 bar - 4 mm Kugel
- Düse & Halter: MASPRA - 519-HD

- Incl. suction hose
- Hose: 3/8" - 15 m - 500 bar
- Hose whip: 1/4" - 1.8 m
- Gun: 500 bar - 4 mm ball
- Tip & base: MASPRA - 519-HD



# HVLP TURBINE SPRAYER

## MA-HVLP-2800

1.400 W | 2.800 ltr./min. | Max. 0.41 bar



Art.-Nr. / Part-No.  
**MA-HVLP-2800**

**MASPRA HVLP Sprayer  
HVLP-2800**  
• Inklusive Schlauch und  
Pistole  
• Stufenlose Drehzahl-  
regelung

**MASPRA HVLP sprayer  
HVLP-2800**  
• including hose and gun  
• Infinitely variable speed  
control for airflow

Art.-Nr. / Part-No.  
**MA-HVLP-SET-xx**

**Düse & Nadel mit Luftkappe  
Nozzle & needle with AirCap**  
1.0 mm .....MA-HVLP-SET-10  
1.2 mm .....MA-HVLP-SET-12  
1.3 mm .....MA-HVLP-SET-13  
1.8 mm .....MA-HVLP-SET-18  
2.0 mm .....MA-HVLP-SET-20  
2.5 mm .....MA-HVLP-SET-25



# HIGH PRESSURE PUMP ACCESSORIES

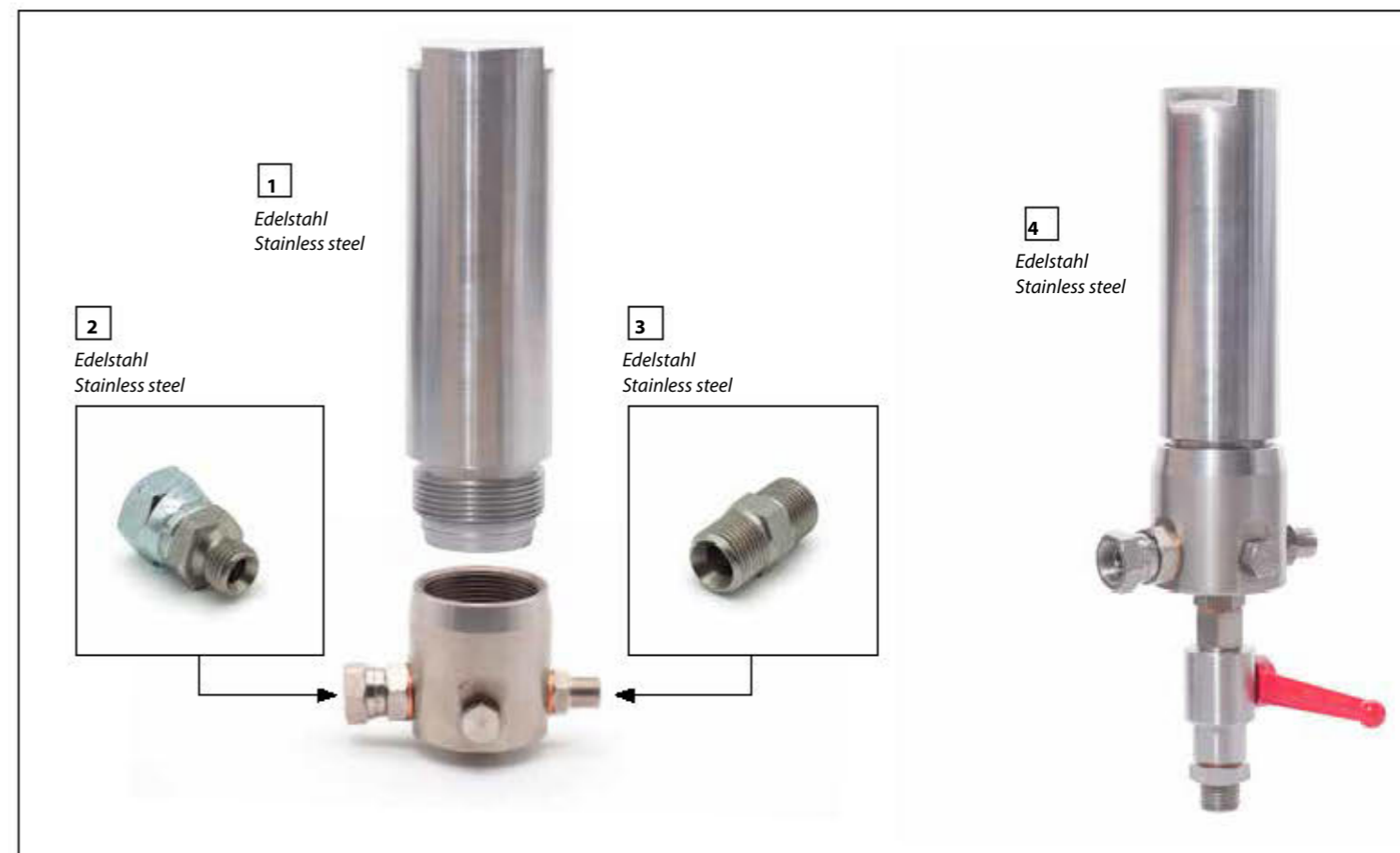

Pos.	Art.-Nr. Part-No.	Artikelbeschreibung Description	Listenpreis List price	Netto-Stückpreis bei Net unit price for
------	----------------------	------------------------------------	---------------------------	--

		€/Stück €/piece		
--	--	--------------------	--	--

### HD-Filtergehäuse / HP-filter housing - 500 bar

1	HP-FI-LO-N	3/8" NPS (F) - 1/4" NPS (M) - Edelstahl / Stainless steel		
---	------------	---	--	--

### HD-Adapter / HP-adapter - 500 bar

2	M1/4NxM1/4N-SS	1/4" NPS (M) x 1/4" NPS (M) - Edelstahl / Stainless steel		
	M1/4NxM3/8N-SS	1/4" NPS (M) x 3/8" NPS (M) - Edelstahl / Stainless steel		
weitere Adapter auf Seite 58 / further adapters on page 58				

### HD-Nippel / HP-nipple - 500 bar

3	M1/4NxM1/4N-SS	1/4" NPS (M) x 1/4" NPS (M) - Edelstahl / Stainless steel		
	M1/4NxM3/8N-SS	1/4" NPS (M) x 3/8" NPS (M) - Edelstahl / Stainless steel		
	M16xM1/4N-SS	M16x1.5 (M) x 1/4" NPS (M) - Edelstahl / Stainless steel		
weitere Nippel auf Seite 105 / further nipples on page 105				

### HD-Filtergehäuse mit Ablasshahn / HP-filter housing with valve - 500 bar

4	HP-FI-LO-N-SET	3/8" NPS (F) - 1/4" NPS (M) - Edelstahl / Stainless steel		
---	----------------	---	--	--



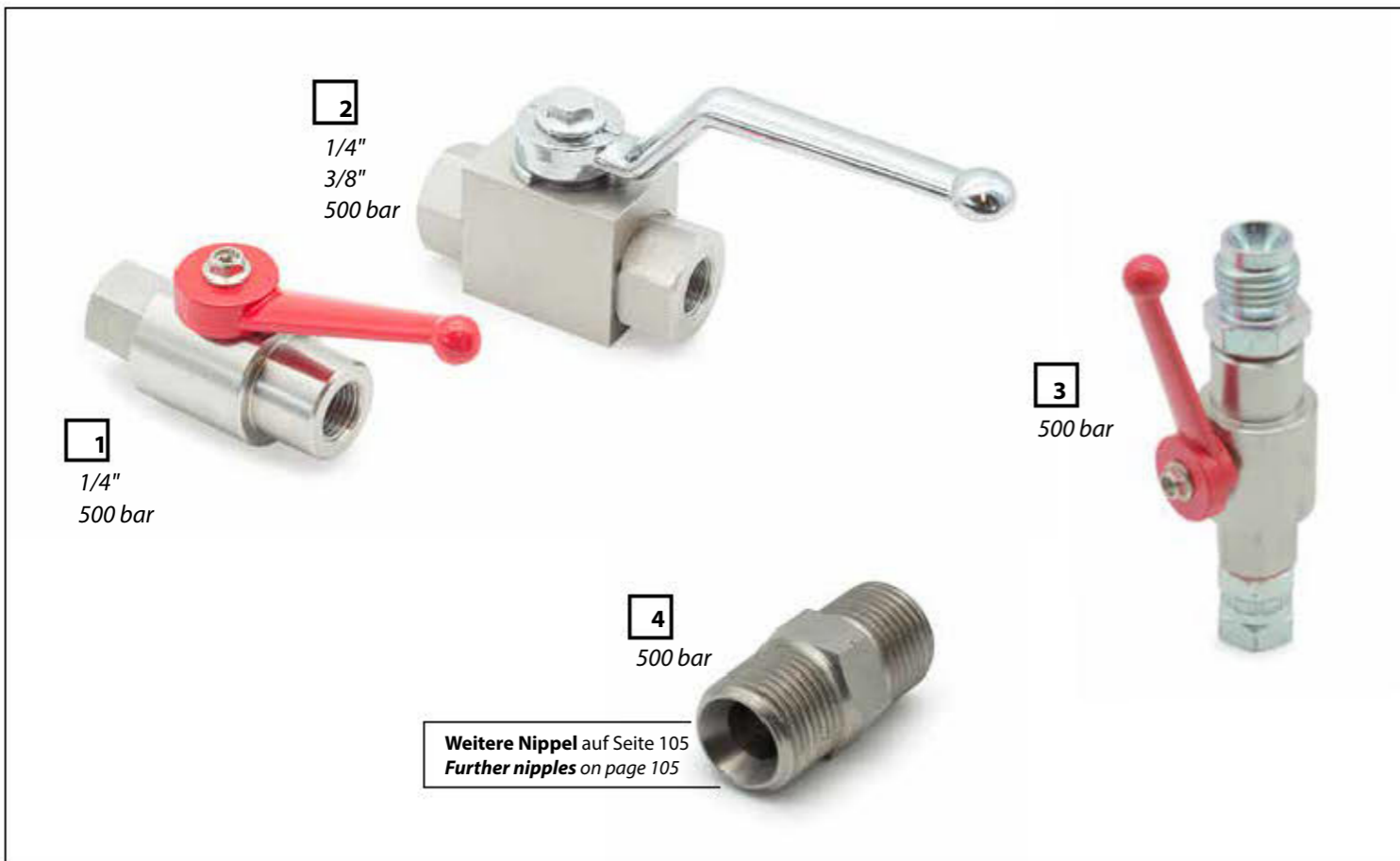

Pos.	Art.-Nr. Part-No.	Artikelbeschreibung Description	Listenpreis List price	Netto-Stückpreis bei Net unit price for
------	----------------------	------------------------------------	---------------------------	--

**Hochdruck Kugelhähne / High pressure ball valves - 500 bar**

1	23010-K-B	G 1/4" BSP - Klein / Small		
	23010-K-N	1/4" NPS - Klein / Small		
	23010-K-B-SS	G 1/4" BSP - Klein Edelstahl / Small stainless steel		
	23010-K-N-SS	1/4" NPS - Klein Edelstahl / Small stainless steel		

2	23010-G-B	G 1/4" BSP - Groß / Big		
	23015-G-N	3/8" NPS - Groß / Big		
	23010-G-B-SS	G 1/4" BSP - Groß Edelstahl / Big stainless steel		
	23010-G-N-SS	1/4" NPS - Groß Edelstahl / Big stainless steel		
	23015-G-B-SS	G 3/8" BSP - Groß Edelstahl / Big stainless steel		
	23015-G-N-SS	3/8" NPS - Groß Edelstahl / Big stainless steel		

3	CA5123	1/4" (F) x M20x2 (M) - A4000-A10000 - Rücklaufhahn / Return valve		
	CA5123-SS	1/4" (F) x M20x2 (M) - SS - A4000-A10000 - Rücklaufhahn / Return valve		

**Hochdruck Verbindungsrippel / High pressure nipples - 500 bar**

4	M1/4BXM1/4B	1/4" BSP (M) x 1/4" BSP (M)		
	M1/4NXM1/4N	1/4" NPS (M) x 1/4" NPS (M)		
	M1/4BXM1/4B-SS	1/4" BSP (M) x 1/4" BSP (M) - SS		
	M1/4NXM1/4N-SS	1/4" NPS (M) x 1/4" NPS (M) - SS		
	M3/8NXM3/8N	3/8" NPS (M) x 3/8" NPS (M)		
	M3/8NXM3/8N-SS	3/8" NPS (M) x 3/8" NPS (M) - SS		



Pos.	Art.-Nr. Part-No.	Artikelbeschreibung Description	Listenpreis List price	Netto-Stückpreis bei Net unit price for
------	----------------------	------------------------------------	---------------------------	--

**Manometer / Gauges**

1	MA-1/4-KPL	Manometeraufnahme / Connection for gauge - 1/4" (F) x 1/4" (M)		
	MA-1/4-KPL-SS	Manometeraufnahme / Connection for gauge - 1/4" (F) x 1/4" (M) - SS		
	MA-M16-KPL	Manometeraufnahme / Connection for gauge - M16x1.5 (F) x 1/4" (M)		
	MA-M16-KPL-SS	Manometeraufnahme / Connection for gauge - M16x1.5 (F) x 1/4" (M) - SS		

2	MANO-DI	Profildichtung für Manometer / Profile seal for gauge		
---	---------	---	--	--

3	MM50A	Ø50 axial		
---	-------	-----------	--	--

4	MM63R	Ø63 radial		
---	-------	------------	--	--

5	MM63A	Ø63 axial		
---	-------	-----------	--	--

6	MK1/4KPL	Manometer Set kpl. / Gauge set cpl. - 1/4" (F) x 1/4" (M)		
	MK1/4KPL-SS	Manometer Set kpl. / Gauge set cpl. - 1/4" (F) x 1/4" (M) - SS		
	MKF16XM1/4	Manometer Set kpl. / Gauge set cpl. - M16 (F) x 1/4" (M)		

7	AC-REG-1	AirCombi Regler - 3/8" Innengewinde • 1/4" Außengewinde AirCombi regulator - 3/8" female thread • 1/4" male thread		
---	----------	---	--	--

8	AL-REG-1	Airless Regler - 3/8" Innengewinde • 1/4" Außengewinde Airless regulator - 3/8" female thread • 1/4" male thread		
---	----------	---	--	--



**Oberbehälter / Hoppers**

Pos.	Art.-Nr. Part-No.	Artikelbeschreibung Description	Listenpreis List price €/Stück €/piece	Netto-Stückpreis bei Net unit price for
<b>6 Liter</b>				
1	520001-TRANS	Oberbehälter mit Deckel / Hopper with lid - M36x2 - transparent		
2	520001-EX	Oberbehälter mit Deckel / Hopper with lid - M36x2 - ATEX - schwarz / black		
3	RL-6	Rücklauf / Return pipe - M20x2		
	RL-6-W-LB	Rücklauf passend WAGNER / Return pipe fitting WAGNER		
4	520001-SS	Oberbehälter mit Deckel - Edelstahl - M36x2 Hopper with lid - stainless steel - M36x2		
<b>30 Liter</b>				
5	520030-M36	Oberbehälter mit Deckel / Hopper with lid - M36x2		
6	RL-30	Rücklauf / Return pipe		
<b>Zubehör / Accessories</b>				
7	ZR-R22	Zwischenring für Reduktion / Adapter for reduction - R22		
	ZR-1/2	Zwischenring für Reduktion / Adapter for reduction - 1/2"		
	DS-R22	Dichtscheibe für Reduktion / Seal plate for reduction - R22		
	DS-1/2	Dichtscheibe für Reduktion / Seal plate for reduction - 1/2"		
8	FI-HÜ	Filterscheibe 20 Maschen / Filter disc 20 mesh - D87 (6 ltr.)		
	FD-59-XXX-LB	Filterscheibe Edelstahl 20/50 Maschen - D59 (30 ltr.) Filter disc stainless steel 20/50 mesh - D59 (30 ltr.)		

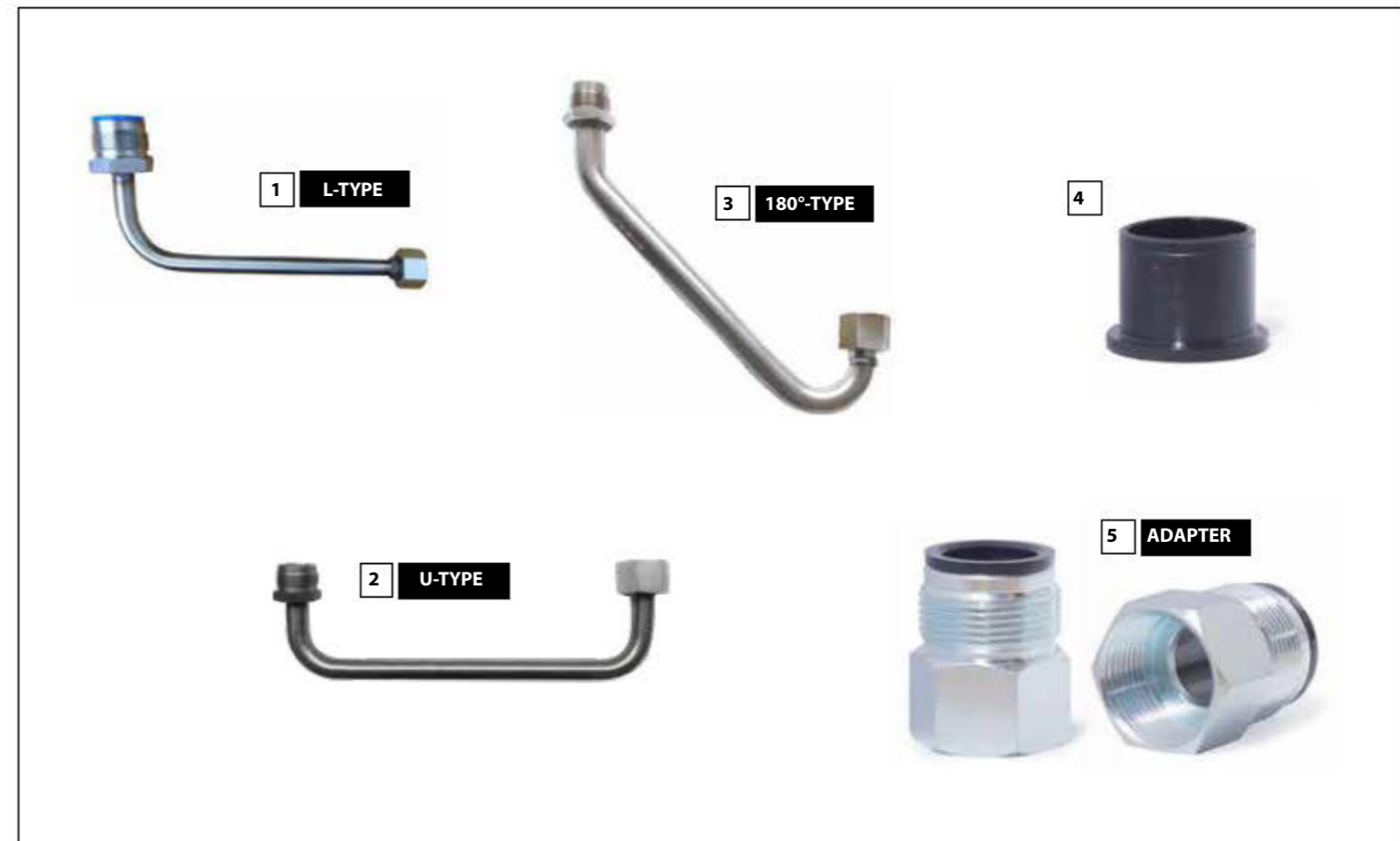

**Ansaugbögen Edelstahl / Suction adapters stainless steel**

Pos.	Art.-Nr. Part-No.	Artikelbeschreibung Description	Listenpreis List price €/Stück €/piece	Netto-Stückpreis bei Net unit price for
1	SUC-L-1/2-SS	L-Ansaugbogen / L-suction adapter - M36x2 x 1/2"		
2	SUC-U-1/2-SS	U-Ansaugbogen / U-suction adapter - M36x2 x 1/2"		
	SUC-U-3/4-SS	U-Ansaugbogen / U-suction adapter - M36x2 x 3/4"		
	SUC-U-M36-SS	U-Ansaugbogen / U-suction adapter - M36x2 x M36x2		
3	SUC-180-3/4-SS	180°-Ansaugbogen / 180°-suction adapter - M36x2 x 3/4"		
	SUC-180-M36-SS	180°-Ansaugbogen / 180°-suction adapter - M36x2 x M36x2		
	SUC-180-M26-SS	180°-Ansaugbogen / 180°-suction adapter - M36x2 x M26x1,25		
<b>Zubehör / Accessories</b>				
4	SUC-GASKET	Dichtung für Ansaugbogen Gasket for suction adapter		
5	SUC-ADAP-F1/2	Adapter für Ansaugbogen / Reduction for suction adapter - M36x2 x 1/2"		
	SUC-ADAP-F3/4	Adapter für Ansaugbogen / Reduction for suction adapter - M36x2 x 3/4"		
	SUC-ADAP-F1	Adapter für Ansaugbogen / Reduction for suction adapter - M36x2 x 1"		

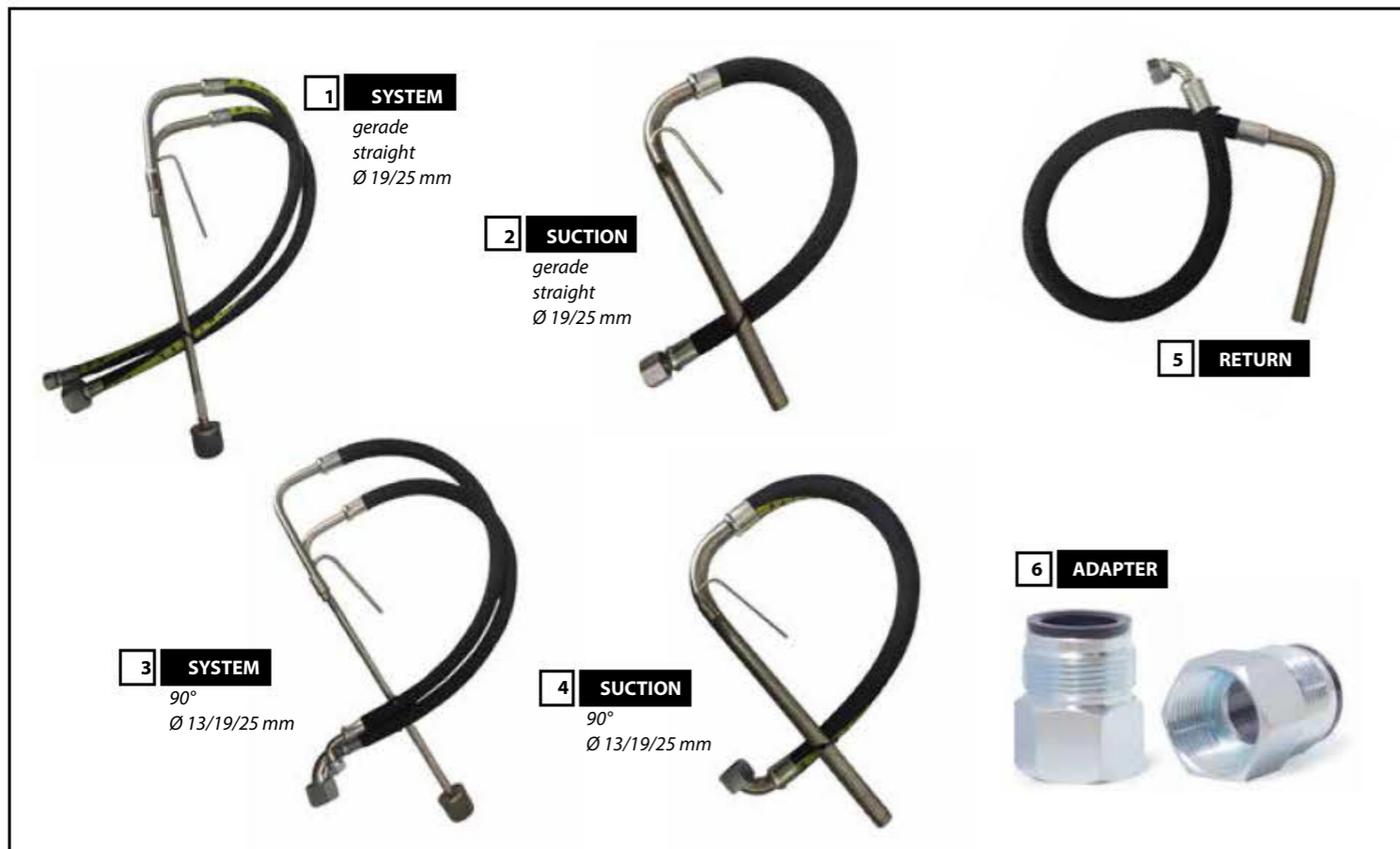

**Flexible Ansaugsysteme / Flexible suction systems**

Pos.	Art.-Nr. Part-No.	Artikelbeschreibung Description	Listenpreis List price	Netto-Stückpreis bei Net unit price for
			€/Stück €/piece	

**Gerade - Edelstahl / Straight - stainless steel - M36x2**

1+2	NW19-VA-KPL	Ø19 Ansaugsystem kpl. / Suction system cpl. - Filter 1/2"		
	NW19AS-VA	Ø19 Ansaugschlauch / Suction hose		
	NW25-VA-KPL	Ø25 Ansaugsystem kpl. / Suction system cpl. - Filter M28		
	NW25AS-VA	Ø25 Ansaugschlauch / Suction hose		

**90° - Edelstahl / 90° - stainless steel - M36x2**

3+4	NW13KPL-90	Ø13 Ansaugsystem kpl. / Suction system cpl. - Filter M15 - Stahl / Mild steel		
	NW13AS-90	Ø13 Ansaugschlauch / Suction hose - Stahl / Mild steel		
	NW19KPL-90-VA	Ø19 Ansaugsystem kpl. / Suction system cpl. - Filter 1/2"		
	NW19AS-90-VA	Ø19 Ansaugschlauch / Suction hose		
	NW25KPL-90-VA	Ø25 Ansaugsystem kpl. / Suction system cpl. - Filter M28		
	NW25AS-90-VA	Ø25 Ansaugschlauch / Suction hose		

**Rücklaufschläuche / Return hoses - M20x2**

5	NW-RS-VA	gerade / straight - Edelstahl / Stainless steel		
	NW-RS-90-VA	90° - Edelstahl / Stainless steel		

**Adapter**

6	SUC-ADAP-F1/2	Adapter für Ansaugbogen / Reduction for suction adapter - M36x2 x 1/2"		
	SUC-ADAP-F3/4	Adapter für Ansaugbogen / Reduction for suction adapter - M36x2 x 3/4"		
	SUC-ADAP-F1	Adapter für Ansaugbogen / Reduction for suction adapter - M36x2 x 1"		



**Ansaugfilter / Suction filters**

Pos.	Art.-Nr. Part-No.	Artikelbeschreibung Description	Listenpreis List price	Netto-Stückpreis bei Net unit price for
			€/Stück €/piece	

1	AF-H-15-XXX	15 Maschen / 15 mesh - 1/2" / 3/4" / 1" / M28 / M38 - Hexagon		
	AF-H-30-M28	30 Maschen / 30 mesh - M28 - Hexagon		

2	ANF-R-15-XXX	15 Maschen / 15 mesh - 1/2" / 3/4" / 7/8" / 1" / M15 / M28 - Round		
	ANF-R-15-3/4-UNF	15 Maschen / 15 mesh - 3/4" UNF - Round		
	ANF-R-30-XXX	30 Maschen / 30 mesh - 1/2" / 3/4" / 1" / M15 / M28 - Round		
	ANF-R-60-XXX	60 Maschen / 60 mesh - 1/2" / M15 - Round		

3	ANF-MINI-1/2	30 Maschen / 30 mesh - 1/2"		
	ANF-MINI-M15	30 Maschen / 30 mesh - M15		

4	2011101	grob / rough - Ø 28		
	2011102	fein / smooth - Ø 28		
	2011103	grob / rough - Ø 22		
	2011104	fein / smooth - Ø 22		

5	FG-KPL-M15-LB	Filterglocke kpl. / Filter housing cpl. - M15x1		
	FG-KPL-1/2-LB	Filterglocke kpl. / Filter housing cpl. - 1/2"		

# ELECTRIC MIXER & SMOOTHING BLADES



Art.-Nr. / Part-No.  
**MA-MIX-1600**

- MASPRA Rührwerk**
- 2 Geschwindigkeitsstufen
  - Stufe I: 250 - 500 rpm
  - Stufe II: 400 - 800 rpm
  - 1.600 Watt
  - Rührflügel Ø 140 mm

- MASPRA Mixer**
- Dual speed
  - Speed I: 250 - 500 rpm
  - Speed II: 400 - 800 rpm
  - 1.600 Watt
  - Paddle Ø 140 mm



Art.-Nr. / Part-No.  
**MA-MIX-1600#6**

- MASPRA Rührstab**  
komplett inklusive Rührflügel
- 590 mm
  - M14 x 2.0

- MASPRA stirring rod**  
complete with propeller
- 590 mm
  - M14 x 2.0



Art.-Nr. / Part-No.  
**MA-SMOOTH-SET**

- MASPRA Flächenspachtel**
- Aluminium
  - 3 Längen: 30 cm, 55 cm und 80 cm
  - Inklusive Ersatzmesser
  - Teleskopstange
  - Aufbewahrungskoffer

- MASPRA smoothing blades**
- Aluminum
  - 3 lengths: 30 cm, 55 cm and 80 cm
  - Including replacement blades
  - Telescopic rod
  - Storage case



OPTION  
PRIVATE LABEL



# SPRAY LANCES BUILDING PROTECTION

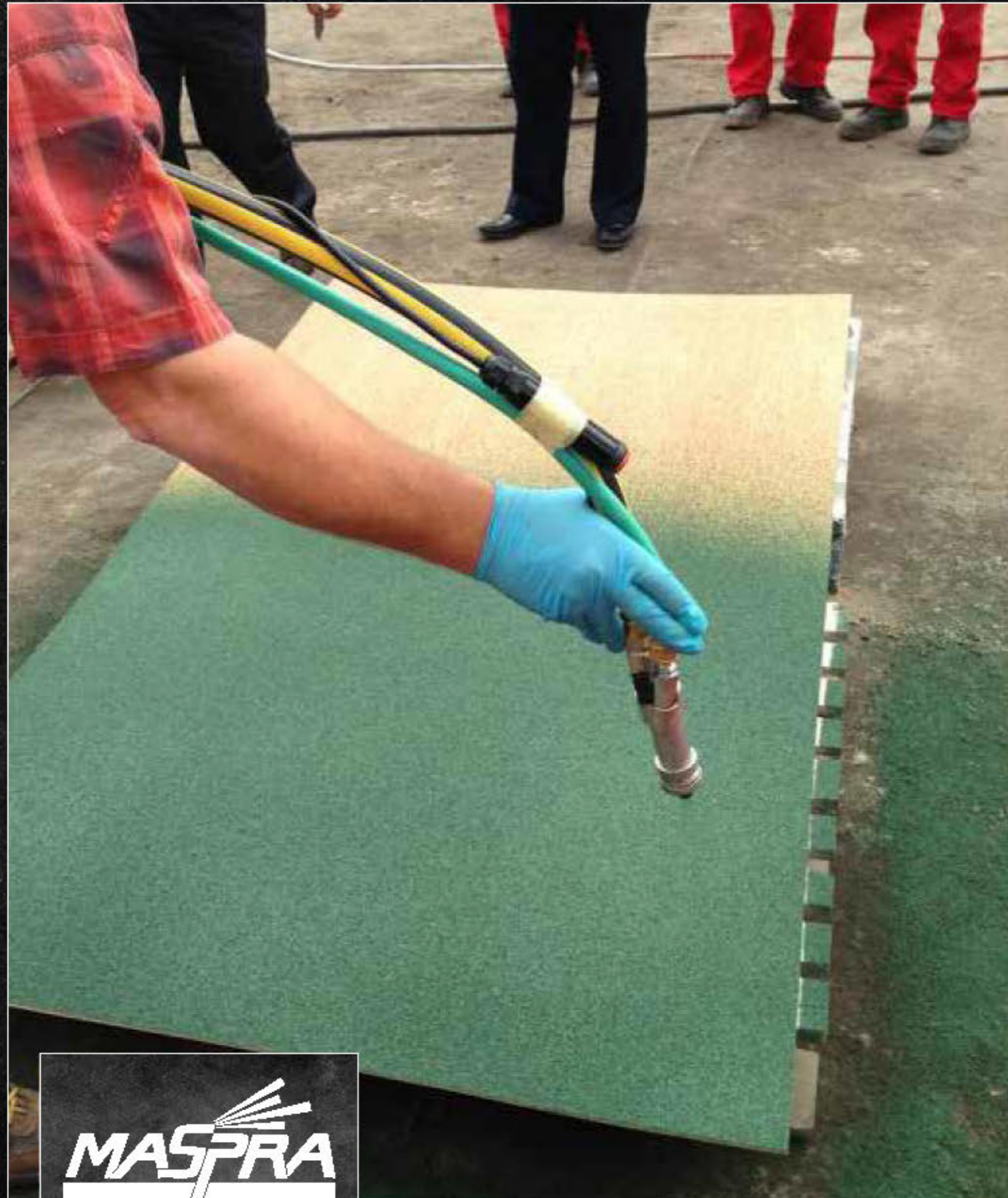

Art.-Nr. / Part-No.  
**MA-SPL-100**

**MASPRA Spritzlanze**  
komplett mit 6.5 mm Düse

**MASPRA Spray lance**  
complete with 6.5 mm nozzle



Art.-Nr. / Part-No.  
**MA-SPL-330**

**MASPRA Spritzlanze**  
lange Ausführung - 330 mm  
komplett mit 6.5 mm Düse

**MASPRA Spray lance**  
long version - 330 mm  
complete with 6.5 mm nozzle



Art.-Nr. / Part-No.  
**MA-786xx**

**Düse für Spritzlanze**  
**Nozzle for spray lance**

4.5 mm ..... MA-78624  
6.5 mm ..... MA-78623  
8.5 mm ..... MA-78622  
10.5 mm ..... MA-78621



Art.-Nr. / Part-No.  
**MA-78625**

**Flachstrahl-Düse**  
**Flat nozzle**





Zuverlässig. Hochwertig. Individuell.  
Preisgünstig.

Wir produzieren CE und ATEX zerti-  
fizierte hochdruck Airless Pistolen für  
die Farbspritztechnik auf höchstem  
Qualitätsniveau.

Leicht, handlich, robust: Das ist MASPRA!

*Reliable. High-quality. Customized.  
Economic.*

*We produce CE and ATEX certified high  
pressure Airless guns for paint spraying  
at the highest quality level.*

*Lightweight, handy, robust: This is MASPRA!*

## **OPTION PRIVATE LABEL**

Option für Großkunden: 100% private label!  
Logo, Farbe und Gravur können bei MASPRA  
Produkten individuell abgestimmt werden,  
ebenso der Lieferumfang sowie das gesamte  
Marketingpaket.

*Quantity buy option: 100% private label!*

*Logo, color and engraving of MASPRA products,  
can be individually customized, as well as the  
scope of delivery and the whole marketing package.*



# **MASTER QUALITY AIRLESS GUNS**

# HIGH PRESSURE AIRLESS SPRAY GUNS

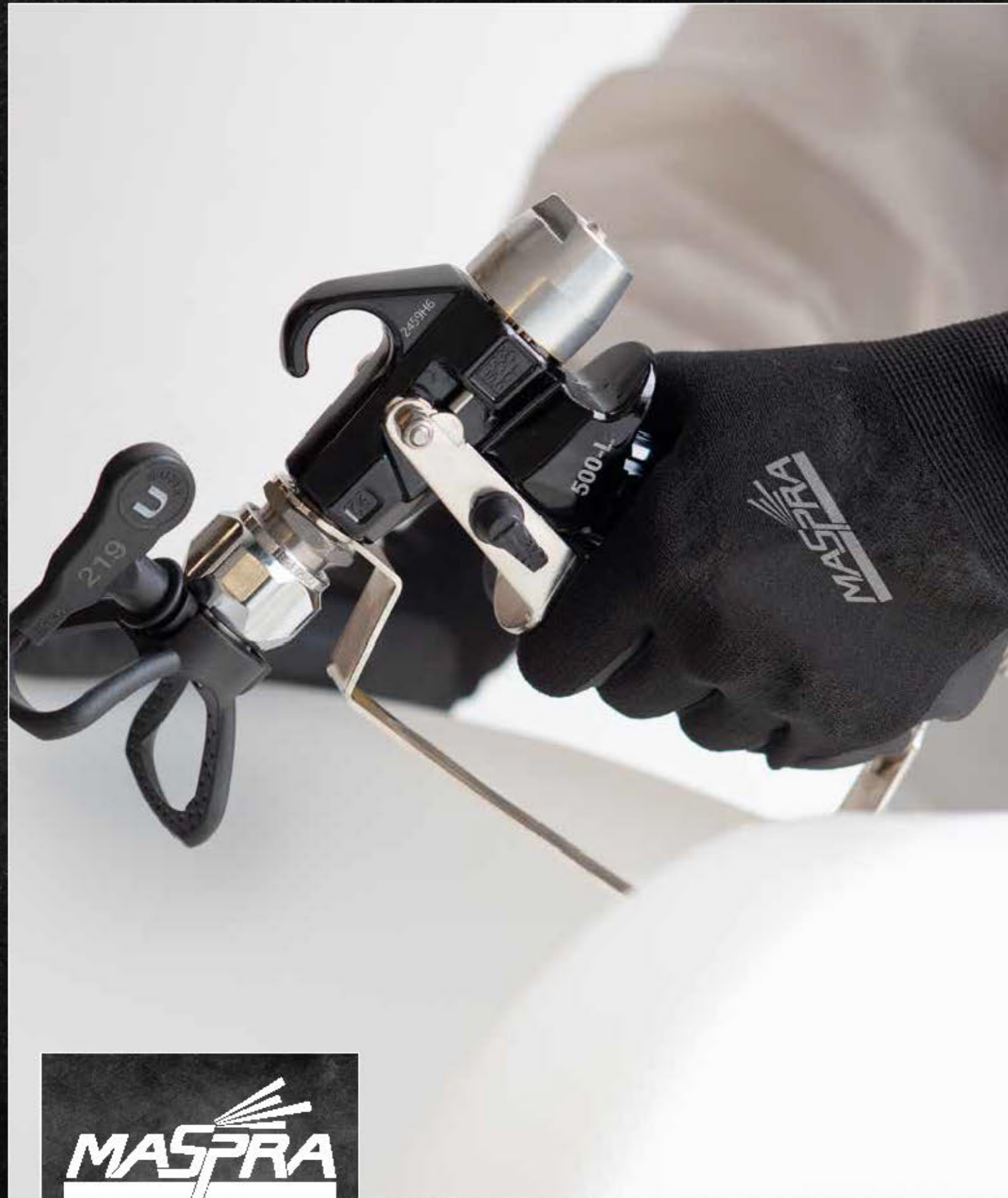

Art.-Nr. / Part-No.  
**MA-AG500**  
7/8"  
**MA-AG500-F**  
11/16"

**MASPRA Airless Pistole  
AG500 inkl. Düsenhalter**  
• 500 bar  
• 3 mm Kugel  
• 7/8" oder 11/16" Diffuser  
• 1/4" Drehgelenk

**MASPRA Airless gun  
AG500 incl. tip base**  
• 500 bar  
• 3 mm ball  
• 7/8" or 11/16" diffuser  
• 1/4" swivel

Art.-Nr. / Part-No.  
**MA-700x-SS**

**M14x1.0 - 500 bar  
Drehgelenk - Edelstahl  
Swivel - stainless steel**

1/4" NPS.....G-7004-SS  
M16x1.5.....G-7005-SS



Art.-Nr. / Part-No.  
**MA-AG500-L**  
7/8"  
**MA-AG500-L-F**  
11/16"

**MASPRA Airless Pistole  
AG500-L inkl. Düsenhalter**  
• 500 bar  
• 5 mm Kugel  
• 7/8" oder 11/16" Diffuser  
• 1/4" Drehgelenk

**MASPRA Airless gun  
AG500-L incl. tip base**  
• 500 bar  
• 5 mm ball  
• 7/8" or 11/16" diffusor  
• 1/4" swivel





Art.-Nr. / Part-No.  
**MA-AG250-LIGHT**

- MASPRA Airless Pistole  
AG250-LIGHT**
- 250 bar
  - 5 mm Kugel
  - 7/8" Diffuser
  - 1/4" Drehgelenk

- MASPRA Airless gun  
AG250-LIGHT**
- 250 bar
  - 5 mm ball
  - 7/8" diffusor
  - 1/4" swivel



Art.-Nr. / Part-No.  
**MA-AG-S**

- MASPRA Airless Pistole  
AG-S**
- 345 bar
  - 4 mm Kugel
  - 7/8" Diffuser
  - 1/4" Anschlussgewinde

- MASPRA Airless gun  
AG-S**
- 345 bar
  - 4 mm ball
  - 7/8" diffusor
  - 1/4" connection thread



Art.-Nr. / Part-No.  
**MA-AG-X7**

- MASPRA Airless Pistole  
AG-X7**
- 500 bar
  - 4 mm Kugel
  - 7/8" Diffuser
  - 1/4" Drehgelenk

- MASPRA Airless gun  
AG-X7**
- 500 bar
  - 4 mm ball
  - 7/8" diffusor
  - 1/4" swivel



Art.-Nr. / Part-No.  
**AG500-G-G-B**  
7/8"

**AG500-G-B**  
11/16"

- Airless Pistole AG500**
- 500 bar
  - 3 mm Kugel
  - 7/8" oder 11/16" Diffuser
  - 1/4" Drehgelenk

- Airless gun AG500**
- 500 bar
  - 3 mm ball
  - 7/8" or 11/16" diffusor
  - 1/4" swivel





Art.-Nr. / Part-No.  
**MA-AG-XXL-G**

**MASPRA Airless Pistole AG-XXL**

- 500 bar
- 7 mm Kugel
- 7/8" Diffuser
- 1/2" Drehgelenk

**MASPRA Airless gun AG-XXL**

- 500 bar
- 7 mm ball
- 7/8" diffuser
- 1/2" swivel



Art.-Nr. / Part-No.  
**MA-AG250-POLE**

**MASPRA Airless Pistole AG250-POLE**

- 250 bar
- 5 mm Kugel
- 7/8" Diffuser
- 1/4" Drehgelenk

**MASPRA Airless gun AG250-POLE**

- 250 bar
- 5 mm ball
- 7/8" diffuser
- 1/4" swivel

Art.-Nr. / Part-No.  
**MA-AG190**

**MASPRA Airless Pistole AG190**

- 250 bar
- 5 mm Kugel
- 7/8" Diffuser
- 3/8" Drehgelenk

**MASPRA Airless gun AG190**

- 250 bar
- 5 mm ball
- 7/8" diffuser
- 3/8" swivel



Art.-Nr. / Part-No.  
**MA-AG250-POLE-KIT**

**MASPRA Airless Kit "Pole"**

- Stabpistole 250 bar
- 1 m Düsenverlängerung
- Master shut-off Ventil
- Halter & Düse - MASPRA 517

**MASPRA Airless kit "Pole"**

- Pole gun 250 bar
- 1 m extension
- Master shut-off valve
- Base & tip - MASPRA 517

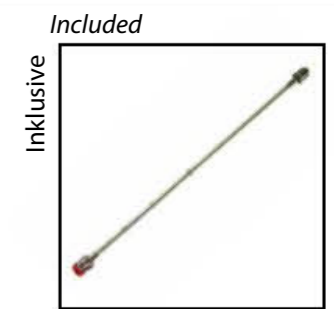

# MASPRA. ALUMINIUM.

## Düsenverlängerungen aus Aluminium.

- Erhältlich in 15/30/50/75/100 cm
- 11/16" oder 7/8" Anschlussgewinde
- Bis max. 250 bar

## Pole extensions made of aluminum.

- Available in 15/30/50/75/100 cm
- 11/16" or 7/8" connection thread
- Up to max. 250 bar



Art.-Nr. Part-No.	Artikelbeschreibung Description	Listenpreis List price €/Stück €/piece	Netto-Stückpreis bei Net unit price for
MA-63-150-F	15 cm - 11/16"		
MA-63-150-G	15 cm - 7/8"		
MA-63-300-F	30 cm - 11/16"		
MA-63-300-G	30 cm - 7/8"		
MA-63-500-F	50 cm - 11/16"		
MA-63-500-G	50 cm - 7/8"		
MA-63-750-F	75 cm - 11/16"		
MA-63-750-G	75 cm - 7/8"		
MA-63-1000-F	100 cm - 11/16"		
MA-63-1000-G	100 cm - 7/8"		

**Mindestabnahme:**  
5 Stk. Mix & Match  
**Minimum order quantity:**  
5 pcs. mix & match



Art.-Nr. / Part-No.  
**MA-63-AH-x**

**MASPRA Kniegelenk**  
• Aluminium  
• max. 250 bar

**MASPRA anglehead**  
• aluminum  
• max. 250 bar

11/16" .....MA-63-AH-F  
7/8" .....MA-63-AH-G

Art.-Nr. / Part-No.  
**MA-SOV-G**

**MASPRA Master Shot  
Shut-off Ventil**  
• 180° drehbar  
• max. 248 bar  
• 7/8" Anschlussgewinde

**MASPRA Master Shot  
Shut-off valve**  
• 180° swivel  
• max. 248 bar  
• 7/8" connection thread



Art.-Nr. / Part-No.  
**MA-LINE-SPRAY**

**MASPRA LineSpray**  
• Spritzhilfe für Kanten  
• max. 250 bar  
• 7/8" Anschlussgewinde

**MASPRA LineSpray**  
• Spray guide painting tool  
• max. 250 bar  
• 7/8" connection thread





Pos.	Art.-Nr. Part-No.	Artikelbeschreibung Description	Listenpreis List price €/Stück €/piece	Netto-Stückpreis bei Net unit price for
------	----------------------	------------------------------------	---	--

**Adapter - Hochdruck / High pressure - 500 bar**

	Außengewinde / Male	Innengewinde / Female	Edelstahl / Stainless steel
1	M1/4Nx16	1/4" NPS	M16x1.5
	M1/4Nx16-SS	1/4" NPS	M16x1.5 ✓
	M1/4Nx3/8N	1/4" NPS	3/8" NPS
	M1/4Nx3/8N-SS	1/4" NPS	3/8" NPS ✓
	M16xF1/4N-SS	M16x1.5	1/4" NPS ✓
	M16xF3/8N	M16x1.5	3/8" NPS
	M3/8Nx1/4N	3/8" NPS	1/4" NPS
	M3/8Nx1/4N-SS	3/8" NPS	1/4" NPS ✓
	M1/2Nx3/8N-SS	1/2" NPS	3/8" NPS ✓

2	W34041-LB	Adapter 1/4" IG (F) - M16x1.5 (M) - Edelstahl / Stainless steel		
---	-----------	---	--	--

**Hochdruckdrehgelenke - Kugelgelagert - High pressure swivels - Ball bearing**

3	G-7009-SS	1/4" NPS (F) x 1/4" NPS (M) - Edelstahl / Stainless steel - 500 bar		
	G-7012-SS	1/4" NPS (F) x 3/8" NPS (M) - Edelstahl / Stainless steel - 500 bar		
	G-7024-SS	3/8" NPS (F) x 3/8" NPS (M) - Edelstahl / Stainless steel - 500 bar		

**Adapter diffusor**

4	MA-32-1/4-7/8	7/8" (F) x 1/4" NPS (M) - Edelstahl / Stainless steel		
5	M778XF11/16	7/8" (M) x 11/16" (F)		



Pos.	Art.-Nr. Part-No.	Artikelbeschreibung Description	Listenpreis List price €/Stück €/piece	Netto-Stückpreis bei Net unit price for
------	----------------------	------------------------------------	---	--

**Injektion / Injection**

1	INJECT11/16	Verpressschlauch inkl. Mundstück ohne Manometer - 11/16" Injection hose incl. jaw grip nozzle without gauge - 11/16"		
	INJECT7/8	Verpressschlauch inkl. Mundstück ohne Manometer - 7/8" Injection hose incl. jaw grip nozzle without gauge - 7/8"		

2	INJECT11/16 MANO	Verpressschlauch inkl. Mundstück und Manometer - 11/16" Injection hose incl. jaw grip nozzle and gauge - 11/16"		
	INJECT7/8 MANO	Verpressschlauch inkl. Mundstück und Manometer - 7/8" Injection hose incl. jaw grip nozzle and gauge - 7/8"		

	LA07725840	Flex. Verpressschlauch / Flex. inject hose - 25 cm		
--	------------	--	--	--

3	LA01840	4-Backen Mundstück / 4-jaw grip nozzle		
---	---------	--	--	--

4	MM50A	Manometer - lösemittelbeständiges Sicherheitsglas - Ø 50 axial Gauge - solvent resistant safety glass - Ø 50 axial		
---	-------	---	--	--

5	MANO-DI	Profildichtung für Manometer / Profile seal for gauge		
---	---------	---	--	--

6	MA-AG250-LIGHT	1/4" - 7/8" - 250 bar		
---	----------------	-----------------------	--	--

**Z-Drehgelenk / Z-swivel - 350 bar**

7	HP-Z-1/4-350	Kupplung verzinkt, 3-fach drehbar - 1/4" (M) x 1/4" (F) Coupling zinc-plated, triple swivel - 1/4" (M) x 1/4" (F)		
---	--------------	--	--	--

# HIGH PRESSURE INNER TUBE COATING

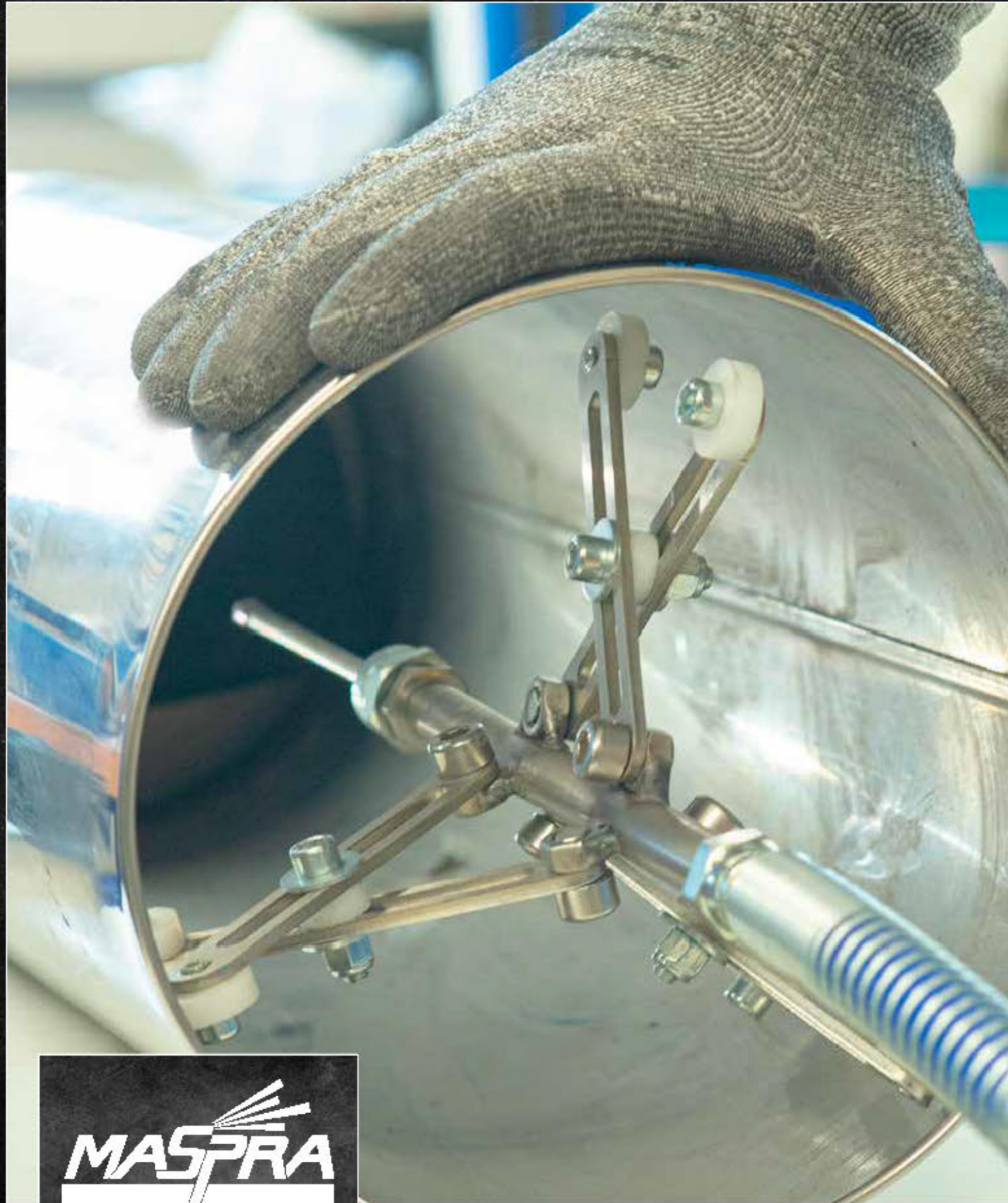

**Rundstrahldüsenystem**  
RST-L separat erhältlich  
**Round jet tip system**  
RST-L separately available



Art.-Nr. / Part-No.  
**MA-PNEU-MINI**

**MASPRA Mini**  
**Rohrinnenbeschichtung**  
**ohne Düsenystem**  
• Ø 50-250 mm  
• 11/16" Diffuser  
• 1/4" Schlauchanschluss

**MASPRA Mini**  
**inner tube coating**  
**without tip system**  
• Ø 50-250 mm  
• 11/16" diffuser  
• 1/4" hose connection

Art.-Nr. / Part-No.  
**MA-PNEU-BIG**

**MASPRA Big**  
**Rohrinnenbeschichtung**  
**ohne Düsenystem**  
• Ø 250-750 mm  
• 11/16" Diffuser  
• 1/4" Schlauchanschluss

**MASPRA Mini**  
**inner tube coating**  
**without tip system**  
• Ø 250-750 mm  
• 11/16" diffuser  
• 1/4" hose connection



**Düsenysteme und Verlängerungen**  
separat erhältlich  
**Tip systems and extensions**  
separately available



**OPTION**  
PRIVATE LABEL



**MADE IN  
EUROPE**

# HIGH PRESSURE AIRCOMBI SPRAY GUNS

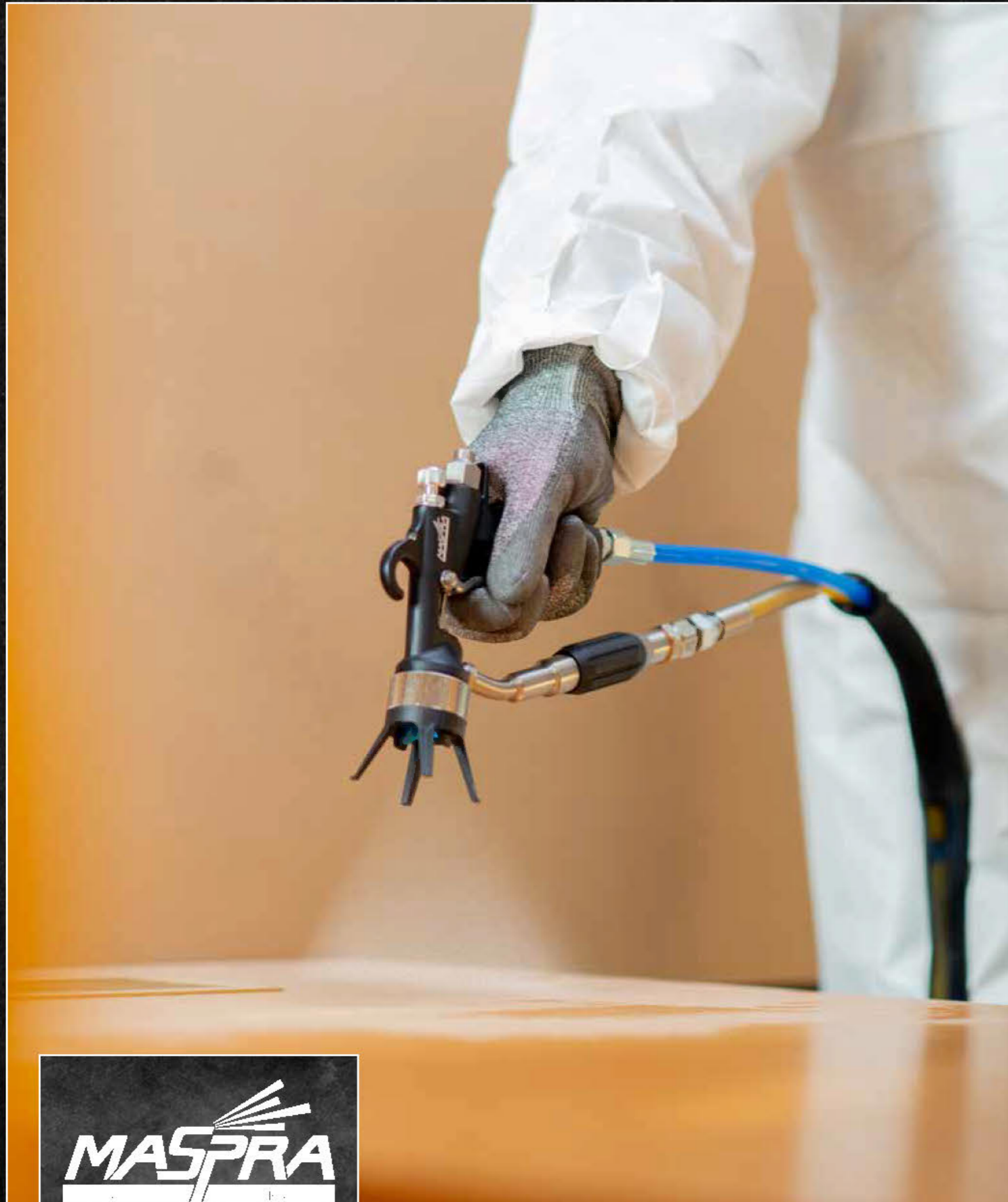

Art.-Nr. / Part-No.  
**MA-M140-R**

**MASPRA AirCombi Pistole  
M140-R - Version Wagner**

- 250 bar
- Inkl. Düse "W" - 411
- Langes Filtergehäuse
- Rote Luftkappe

**MASPRA AirCombi gun  
M140-R - Version Wagner**

- 250 bar
- Incl. nozzle "W" - 411
- Long filter housing
- Red AirCap



Art.-Nr. / Part-No.  
**MA-M140-B**

**MASPRA AirCombi Pistole  
M140-B - Version Wagner**

- 250 bar
- Inkl. Düse "W" - 411
- Langes Filtergehäuse
- Blaue Luftkappe

**MASPRA AirCombi gun  
M140-B - Version Wagner**

- 250 bar
- Incl. nozzle "W" - 411
- Long filter housing
- Blue AirCap



Art.-Nr. / Part-No.  
**MA-M150**

**MASPRA AirCombi Pistole  
M150 - Version MT-U**

- 250 bar
- Inkl. Wendedüse  
MASPRA FineFinish 410
- Langes Filtergehäuse

**MASPRA AirCombi gun  
M150 - Version MT-U**

- 250 bar
- Incl. reversible tip  
MASPRA FineFinish 410
- Long filter housing



Art.-Nr. / Part-No.  
**M110-S-O-R**  
 Filter Optima  
**M110-S-L-R**  
 Filter lang / long

**AirCombi Pistole M110 - Version Optima 2000**  
 • 250 bar  
 • Inkl. Düse "Rund" - 428 und Luftkappe  
 • Kurzes oder langes Filtergehäuse

**AirCombi gun M110 - Version Optima 2000**  
 • 250 bar  
 • Incl. nozzle "round" - 428 and AirCap  
 • Short or long filter housing



Art.-Nr. / Part-No.  
**M120-S-L-K**

**AirCombi Pistole M120 - Version Kremlin**  
 • 250 bar  
 • Inkl. Düse "KR" - 06.094 und Luftkappe  
 • Langes Filtergehäuse

**AirCombi gun M120 - Version Kremlin**  
 • 250 bar  
 • Incl. nozzle "KR" - 06.094 and AirCap  
 • Long filter housing



Art.-Nr. / Part-No.  
**M110-S-L-H**

**AirCombi Pistole M110 - Version Optima 2100**  
 • 250 bar  
 • Inkl. Düse "sechskant" - 428 und Luftkappe  
 • Langes Filtergehäuse

**AirCombi gun M110 - Version Optima 2100**  
 • 250 bar  
 • Incl. nozzle "hexagon" - 428 and AirCap  
 • Long filter housing



Art.-Nr. / Part-No.  
**M140-S-L-W-R**  
 Rot / Red  
**M140-S-L-W-B**  
 Blau / Blue

**AirCombi Pistole M140 - Version Wagner**  
 • 250 bar  
 • Inkl. Düse "W" - 411  
 • Langes Filtergehäuse  
 • Blaue oder rote Luftkappe

**AirCombi gun M140 - Version Wagner**  
 • 250 bar  
 • Incl. nozzle "W" - 411  
 • Long filter housing  
 • Blue or red AirCap



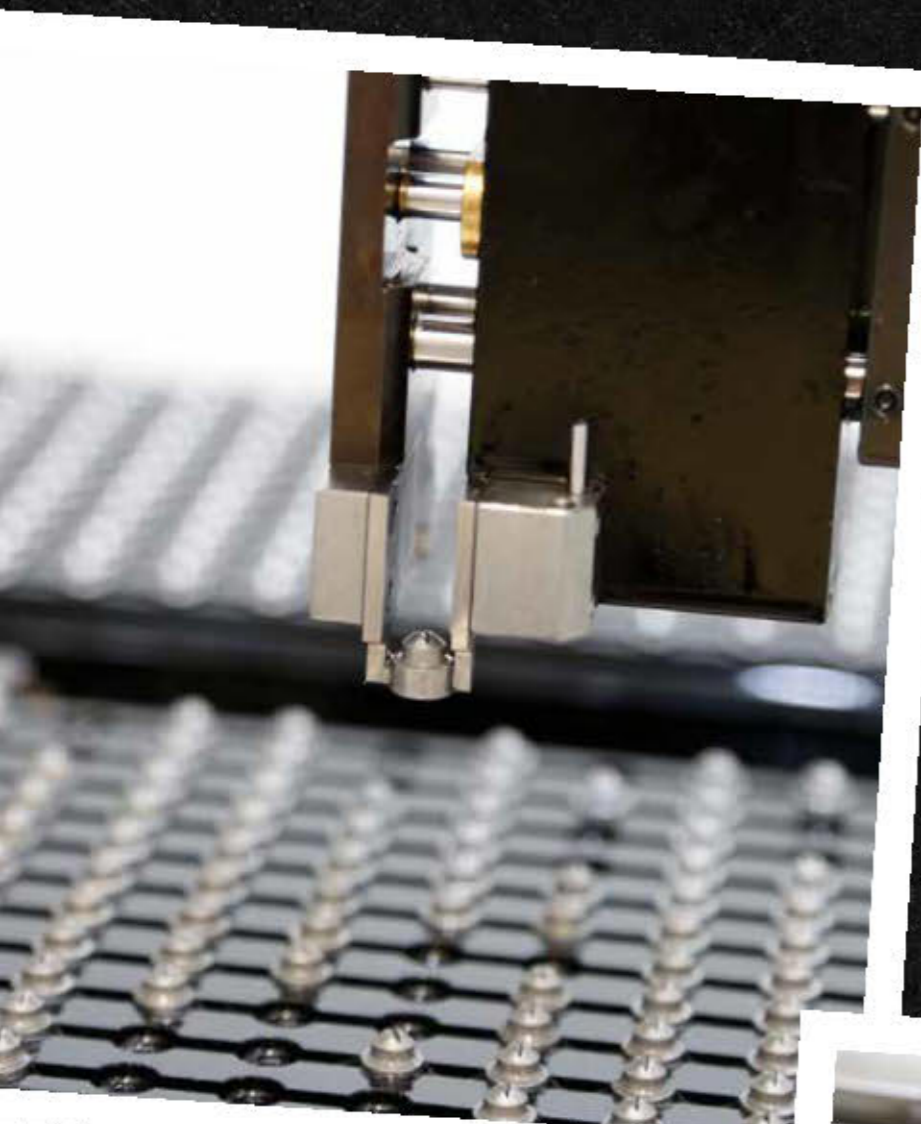

**Eigene Düsenproduktion.  
Made in Germany.**

An unserem Standort in Friedrichshafen produzieren wir Wolfram Carbid **Hartmetall Düsen** für den Einsatz im Bereich der **Spritztechnik**.

Eingebaut in **gehärtete Edelstahlträger**, bieten MASPRA Düsen sowohl für das **Airless**, als auch für das **AirCombi** Spritzverfahren, die beste Lösung.

**Own tip production.  
Made in Germany.**

On our site in Friedrichshafen, we produce **tungsten carbide tips** for spraying technology.

Mounted into **hardened stainless steel** housings, MASPRA tips are the best solution for **Airless & AirCombi** application.

**Nichts dem Zufall überlassen.**

Durch einen **vollautomatischen Schleifprozess**, sowie computergesteuerte Messungen und **Qualitätsprüfungen**, garantieren wir eine gleichbleibende **Spitzenqualität**.

Perfektes Spritzbild bei langer Lebensdauer:  
**Das ist MASPRA!**

**Focused on Quality.**

Through a **fully automatic grinding process**, as well as computer-controlled measurements and **quality checks**, we guarantee a consistent **top product**.

Perfect spray pattern with a long service life:  
**This is MASPRA!**



**MASTER QUALITY  
SPRAY TIPS**

 **OPTION  
PRIVATE LABEL**

**MADE IN  
GERMANY** 

# HIGH PRESSURE AIRLESS FLAT JET TIPS

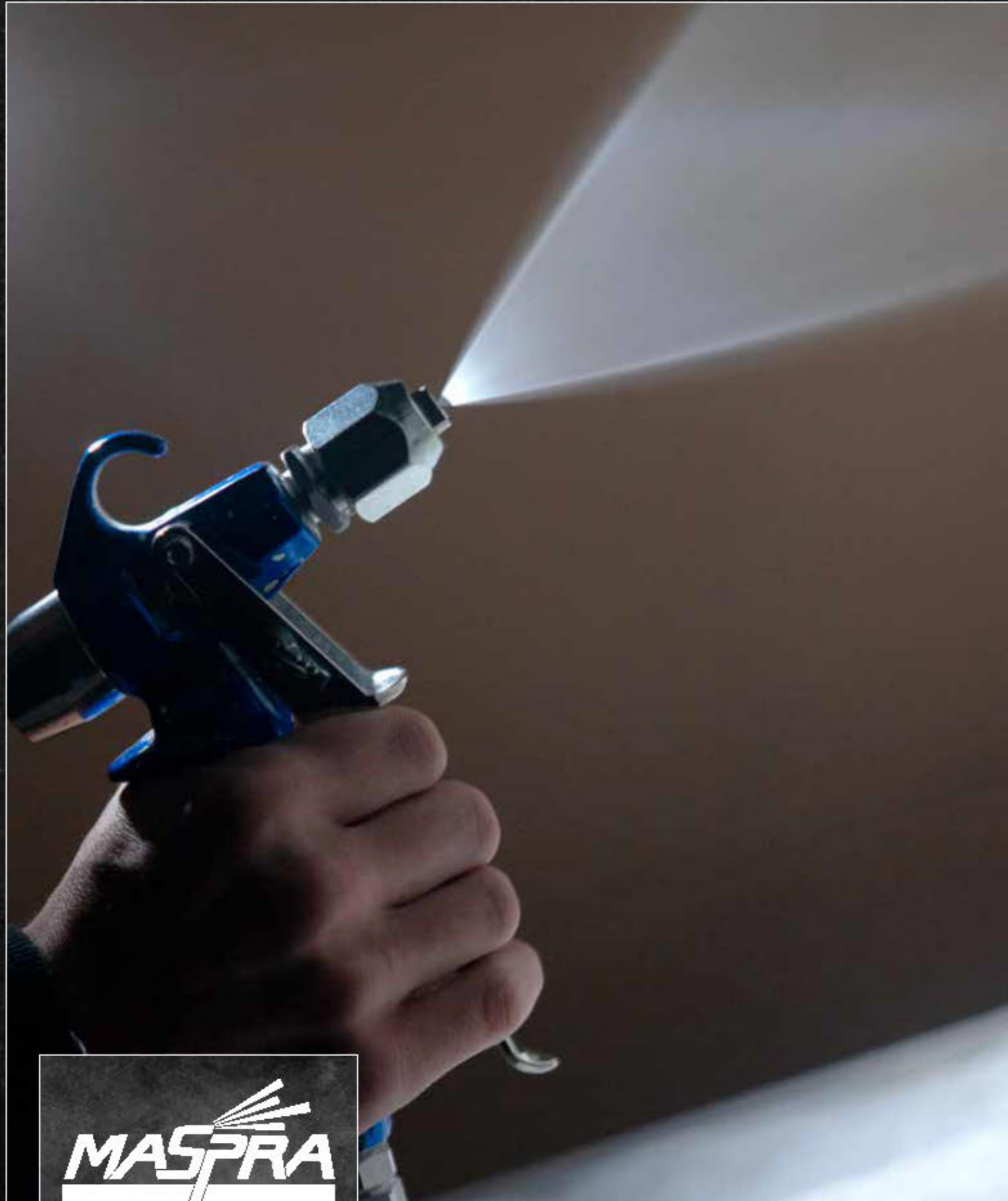

Art.-Nr. / Part-No.  
**MA-163-xxx-FF-SS**

**MASPRA Airless  
Flachstrahldüse Lang**  
• Mit Vorzerstäuber  
• Edelstahlgehäuse  
• Inklusive Dichtung

**MASPRA Airless  
Flat jet tip long**  
• With preorifice  
• Stainless steel housing  
• Including seal



**OPTION**  
PRIVATE LABEL

**MADE IN GERMANY**

Eigene Düsenproduktion  
Own tip production

Art.-Nr. / Part-No.  
**MA-93-xxx-SS**  
Standard

**MASPRA MA-Version  
Flachstrahldüse kurz**  
• Edelstahlgehäuse  
• Standard

**MASPRA MA-Version  
Flat jet tip short**  
• Stainless steel housing  
• Standard

Art.-Nr. / Part-No.  
**MA-93-xxx-FF-SS**  
FineFinish

**MASPRA MA-Version  
Flachstrahldüse kurz**  
• Edelstahlgehäuse  
• Mit Vorzerstäuber

**MASPRA MA-Version  
Flat jet tip short**  
• Stainless steel housing  
• With preorifice



**MASPRA**  
SPRAY PARAMETER

Entspricht in Durchflussmenge und  
Spritzstrahlwinkel dem Durchschnitt  
der bekannten Herstellermodelle.

Matches the flow rate and spray  
angle parameters of the average of  
well-known manufacturer models.

**OPTION**  
PRIVATE LABEL

**MADE IN GERMANY**

Eigene Düsenproduktion  
Own tip production





Art.-Nr. / Part-No.  
**MA-93-W-xxx-SS**  
Standard

**MASPRA W-Version**  
Flachstrahldüse kurz  
• Edelstahlgehäuse  
• Standard

**MASPRA W-Version**  
Flat jet tip short  
• Stainless steel housing  
• Standard

Art.-Nr. / Part-No.  
**MA-93-W-xxx-FF-SS**  
FineFinish

**MASPRA W-Version**  
Flachstrahldüse kurz  
• Edelstahlgehäuse  
• Mit Vorzerstäuber

**MASPRA W-Version**  
Flat jet tip short  
• Stainless steel housing  
• With preorifice

**WAGNER**  
SPRAY PARAMETER

Entspricht in Durchflussmenge und Spritzstrahlwinkel den Parametern der WAGNER Standarddüsen.

*Matches the flow rate and spray angle parameters of the WAGNER standard tips.*

**OPTION**  
PRIVATE LABEL

**MADE IN GERMANY**

Eigene Düsenproduktion  
Own tip production



Art.-Nr. / Part-No.  
**MA-93-GR-xxx-SS**  
Standard

**MASPRA GR-Version**  
Flachstrahldüse kurz  
• Edelstahlgehäuse  
• Standard

**MASPRA GR-Version**  
Flat jet tip short  
• Stainless steel housing  
• Standard

Art.-Nr. / Part-No.  
**MA-93-GR-xxx-FF-SS**  
FineFinish

**MASPRA GR-Version**  
Flachstrahldüse kurz  
• Edelstahlgehäuse  
• Mit Vorzerstäuber

**MASPRA GR-Version**  
Flat jet tip short  
• Stainless steel housing  
• With preorifice

**GRACO**  
SPRAY PARAMETER

Entspricht in Durchflussmenge und Spritzstrahlwinkel den Parametern der GRACO Standarddüsen.

*Matches the flow rate and spray angle parameters of the GRACO standard tips.*

**OPTION**  
PRIVATE LABEL

**MADE IN GERMANY**

Eigene Düsenproduktion  
Own tip production



Art.-Nr. / Part-No.  
**MA-93-TI-xxx-SS**  
Standard

**MASPRA TI-Version**  
Flachstrahldüse kurz  
• Edelstahlgehäuse  
• Standard

**MASPRA TI-Version**  
Flat jet tip short  
• Stainless steel housing  
• Standard

Art.-Nr. / Part-No.  
**MA-93-TI-xxx-FF-SS**  
FineFinish

**MASPRA TI-Version**  
Flachstrahldüse kurz  
• Edelstahlgehäuse  
• Mit Vorzerstäuber

**MASPRA TI-Version**  
Flat jet tip short  
• Stainless steel housing  
• With preorifice

**TITAN**  
SPRAY PARAMETER

Entspricht in Durchflussmenge und Spritzstrahlwinkel den Parametern der TITAN Standarddüsen.

*Matches the flow rate and spray angle parameters of the TITAN standard tips.*

**OPTION**  
PRIVATE LABEL

**MADE IN GERMANY**

Eigene Düsenproduktion  
Own tip production

Art.-Nr. / Part-No.  
**MA-NUT-11/16**

**MASPRA Überwurfmutter**  
• 11/16"  
• Normalstahl Variante

**MASPRA wrap nut**  
• 11/16"  
• Normal steel version

Art.-Nr. / Part-No. Art.-Nr. / Part-No.  
**MA-NUT-7/8**

**MASPRA Überwurfmutter**  
• 7/8"  
• Normalstahl

**MASPRA wrap nut**  
• 7/8"  
• Normal steel



Art.-Nr. / Part-No.  
**MA-NUT-11/16-SS**

• Edelstahl Variante  
• Stainless steel version



Art.-Nr. / Part-No.  
**W43052-LB**

Dichtung für Standarddüsen

Seal for standard tips



# HIGH PRESSURE AIRLESS ROUND JET TIPS

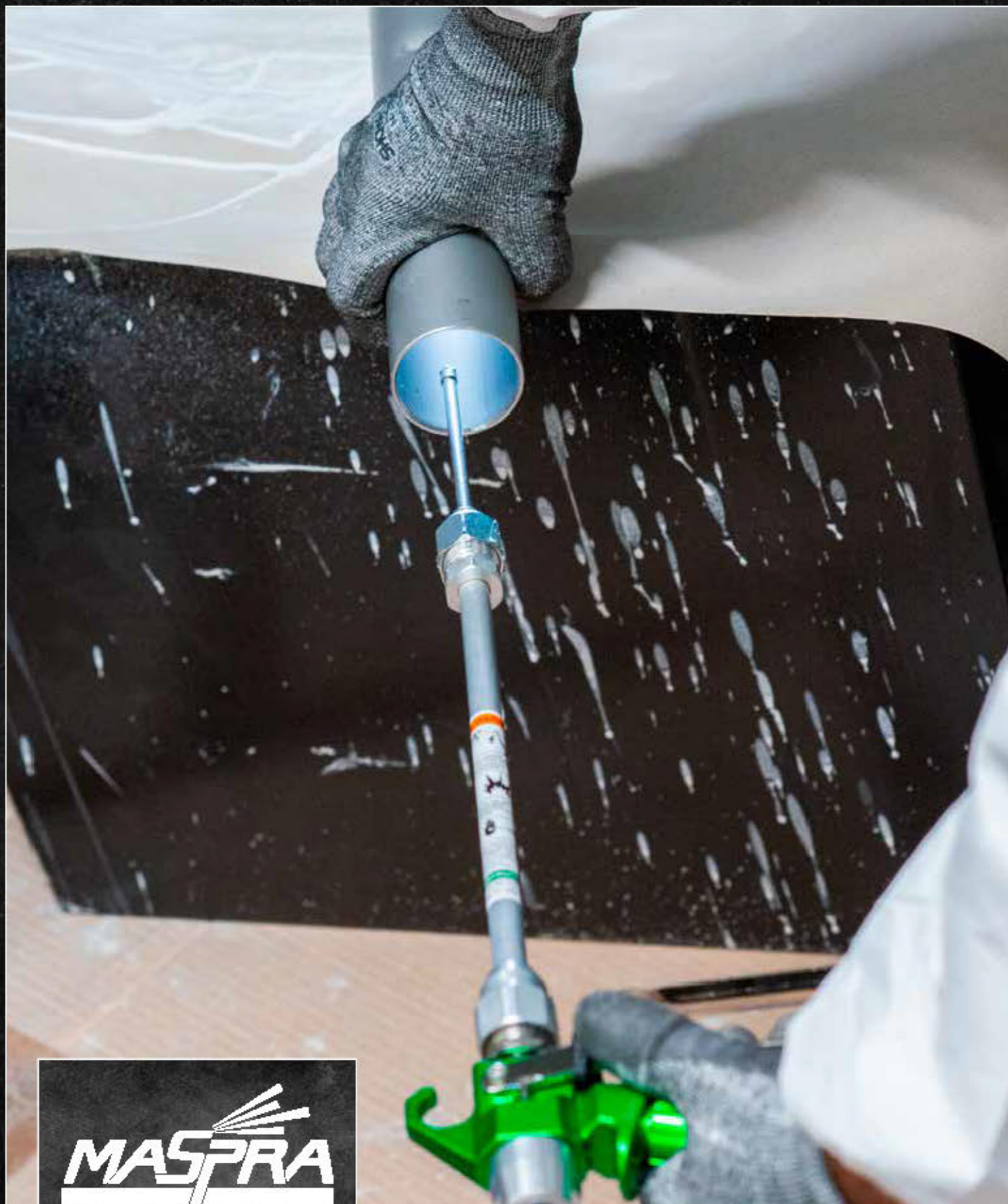

**1 ROUND**  
inkl. Vorzerstäuber  
incl. preorifice



**2 LANCE**  
Hohlraumlanze kpl.  
Cavity lance cpl.



**3 FLEX-HOSE**  
Verschiedene Längen möglich  
Various lengths possible



**4 ADAPTER**



**5 E-STATIC**  
Rundstrahldüse inkl. E-Statik Aufnahme  
Round jet tip incl. e-static support

Eigene Düsenproduktion  
Own tip production



## Rundstrahl / Round jet

Pos.	Art.-Nr. Part-No.	Artikelbeschreibung Description	Listenpreis List price €/Stück €/piece	Netto-Stückpreis bei Net unit price for
------	----------------------	------------------------------------	---	--

## Hohlraumkonservierung / Cavity preservation

1	MA-RST-11	Rundstrahldüse inkl. Vorzerstäuber / Round jet tip incl. preorifice R11 - 0.16 Ltr./min. (100 bar)		
	MA-RST-15	Rundstrahldüse inkl. Vorzerstäuber / Round jet tip incl. preorifice R15 - 0.38 Ltr./min. (100 bar)		
	MA-RST-16	Rundstrahldüse inkl. Vorzerstäuber / Round jet tip incl. preorifice R16 - 0.43 Ltr./min. (100 bar)		
2	MA-RST-L-120-Rxx-F	Hohlraumlanze 120 mm inkl. Düse nach Wahl R11, R15 oder R16 und Überwurfmutter 11/16" Cavity lance 120 mm incl. tip of your choice R11, R15 or R16 and wrap nut 11/16"		
	MA-RST-L-120-Rxx-G	Hohlraumlanze 120 mm inkl. Düse nach Wahl R11, R15 oder R16 und Überwurfmutter 7/8" Cavity lance 120 mm incl. tip of your choice R11, R15 or R16 and wrap nut 7/8"		
3	MA-T-1/8-08-RST	Flexibler Schlauch für Hohlraumkonservierung - 80 mm inkl. Aufnahme für Rundstrahldüse (Düse RST-xx separat erhältlich) Flexible hose for cavity preservation - 80 mm incl. support for round jet tip (Tip RST-xx separately available)		

## Adapter diffusor

4	MA-32-1/4-7/8	7/8" (F) x 1/4" NPS (M) - Edelstahl / Stainless steel		
---	---------------	---	--	--

## Rundstrahldüse Elektrostatik / Round jet tip electrostatic

5	MA-RST-E-Rxx	Rundstrahldüse für Elektrostatik inkl. Aufnahme - 11/15/16 Round jet tip for Electrostatic incl. support - 11/15/16		
---	--------------	--	--	--

# HIGH PRESSURE AIRLESS REVERSIBLE SPRAY TIPS

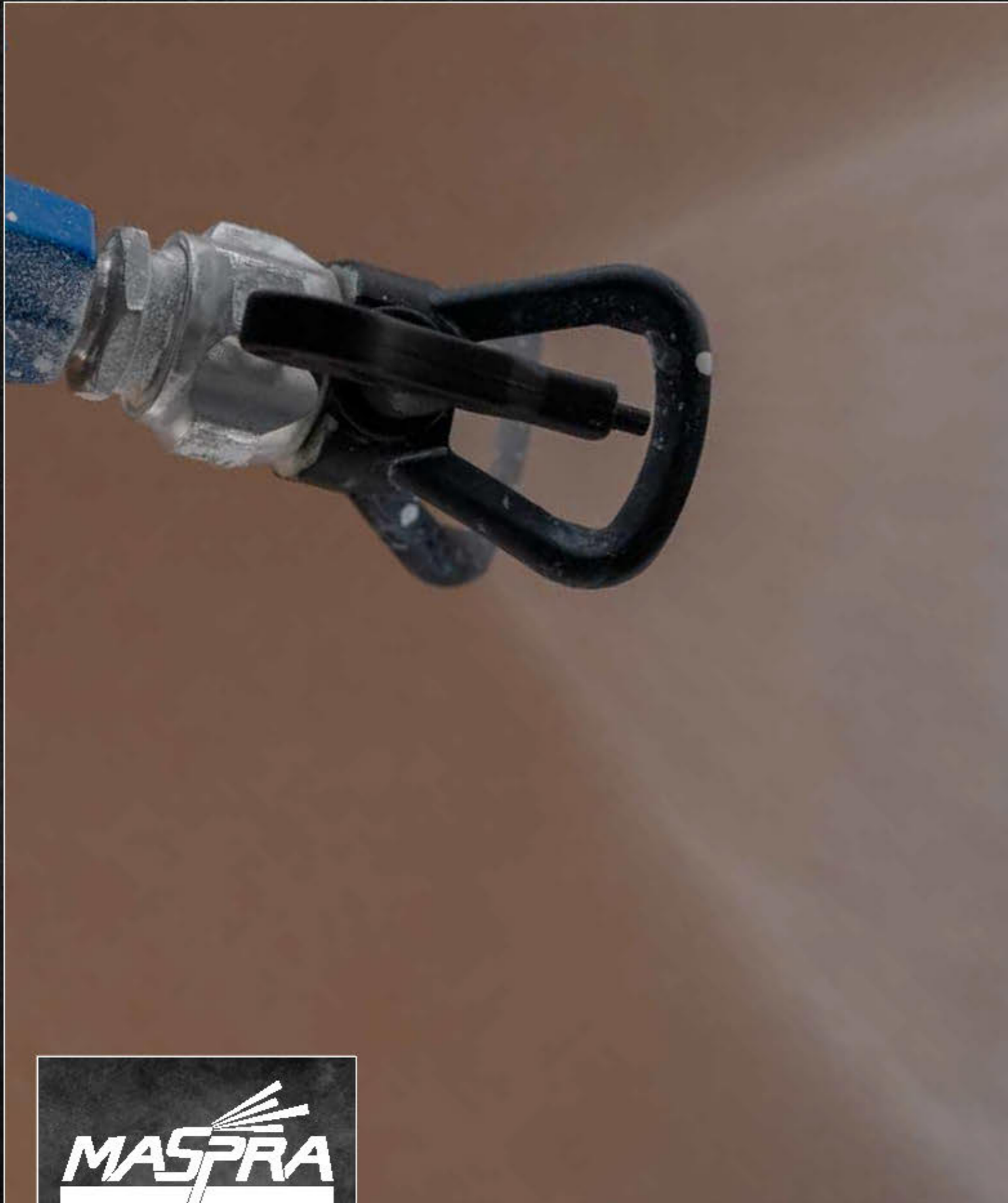

Art.-Nr. / Part-No.  
**MT-U-V-xxx**  
Standard

**APEQ WIWA Universal**  
Standard - max. 280 bar

Art.-Nr. / Part-No.  
**MT-U-V-xxx-FF**  
FineFinish

**APEQ WIWA Universal**  
FineFinish - max. 280 bar

Mit Vorzerstäuber  
*With preorifice*

Art.-Nr. / Part-No.  
**MT-U-V-xxx-HD**  
Heavy Duty

**APEQ WIWA Universal**  
Heavy Duty - max. 500 bar

Hochdruck  
*High pressure*

Art.-Nr. / Part-No.  
**MT-U-V-xxx-ST**  
Striping

**APEQ WIWA Universal**  
Striping - max. 280 bar

Markierdüse  
*Line marking*

Art.-Nr. / Part-No.  
**MT-U-V-xxx-LP**  
Low Pressure

**APEQ WIWA Universal**  
Low Pressure - max. 280 bar

Niederdruck  
*Low pressure*

**OPTION**  
PRIVATE LABEL

**MADE IN**  
**GERMANY**

Von 0-500 bar - Jede Größe produzierbar  
From 0-500 bar - Each size can be produced



**AirCombi Düsen aus Deutschland.**

MASPRA AirCombi Düsen sind die **hochwertige, zuverlässige** und **preiswerte Alternative**.

Alle Düsen sind **kompatibel** mit den Luftkappen aus eigener Produktion oder der Original-Hersteller.

Diese sind in verschiedenen Ausführungen erhältlich und **austauschbar mit den bekannten Marken**.

**AirCombi tips from Germany.**

MASPRA AirCombi tips are the **high-quality, reliable** and **economic alternative**.

All tips are **compatible** with our own AirCaps or with those of original manufacturers.

These are available in different versions and is **interchangeable with the well-known brands**.

**MASPRA**

**kompatibel mit  
compatible with**

Type "O-R"

Optima 2000

Type "O-H"

Optima 2100

Type "GR"

Graco AAM/AAF/AXM/AXF

Type "KR"

Kremlin

Type "W"

Wagner 379xxx

Type "S"

Sagola



 **OPTION**  
PRIVATE LABEL

MADE IN   
GERMANY



**MASTER QUALITY  
AIRCOMBI TIPS**

# HIGH PRESSURE AIRCOMBI SPRAY TIPS



**OPTION PRIVATE LABEL** **MADE IN GERMANY** Eigene Düsenproduktion  
Own tip production

AirCombi				
Pos.	Art.-Nr. Part-No.	Artikelbeschreibung Description	Listenpreis List price €/Stück €/piece	Netto-Stückpreis bei Net unit price for
<b>Type "O-R" - OPTIMA 2000</b>				
1	MA-AC-O-xxx-LB	Düse runde Ausführung Tip round version		
2	MA-AC-O-R-LB	Luftkappe runde Ausführung AirCap round version		
3	MA-AC-O-SEAL-LB	Düsendichtung runde Ausführung (10x) Tip seal round version (10x)		
<b>Type "O-H" - OPTIMA 2100</b>				
4	MA-AC-O-H-xxx-LB	Düse sechskant Ausführung Tip hexagon version		
5	MA-AC-O-H-LB	Luftkappe sechskant Ausführung AirCap hexagon version		
6	MA-AC-O-H-SEAL-LB	Düsendichtung sechskant Ausführung (1x) Tip seal hexagon version (1x)		



**AirCombi**

Pos.	Art.-Nr. Part-No.	Artikelbeschreibung Description	Listenpreis List price	Netto-Stückpreis bei Net unit price for
			€/Stück €/piece	

**Type "GR" - GRACO AAM/AAF/AXM/AXF**

1	MA-AC-GR-AA-xxx-LB	Düse Typ "AA" Tip type "AA"		
	MA-AC-GR-AF-xxx-LB	Düse Typ "AF" - Mit Vorzerstäuber Tip type "AF" - With preorifice		

2	MA-AC-GR-AX-xxx-LB	Düse Typ "AX" Tip type "AX"		
	MA-AC-GR-AXF-xxx-LB	Düse Typ "AXF" - Mit Vorzerstäuber Tip type "AXF" - With preorifice		

3	MA-AC-GR-SEAL-LB	Düsendichtung "GR" Ausführung (10x) Tip seal "GR" version (10x)		
---	------------------	--	--	--

**Type "KR" - KREMLIN**

4	MA-AC-65-xxxx4-LB	Düse standard Ausführung Tip standard version		
	MA-AC-65-xxxx2-LB	Düse mit Vorzerstäuber Tip with preorifice		

5	MA-AC-6524-LB	Luftkappe Typ "24" AirCap type "24"		
---	---------------	--	--	--

6	MA-AC-65-SEAL-LB	Düsendichtung "KR" Ausführung (10x) Tip seal "KR" version (10x)		
---	------------------	--	--	--



**AirCombi**

Pos.	Art.-Nr. Part-No.	Artikelbeschreibung Description	Listenpreis List price	Netto-Stückpreis bei Net unit price for
			€/Stück €/piece	

**Type "W" - WAGNER 379**

1	MA-AC-W4-xxx-LB	Düse standard Ausführung - Edelstahl Tip standard version - stainless steel		
---	-----------------	--	--	--

2	MA-AC-W47-R-LB	Luftkappe rote Ausführung AirCap red version		
	MA-AC-W47-B-LB	Luftkappe blaue Ausführung AirCap blue version		

3	MA-AC-W4-SEAL-LB	Düsendichtung "W4" Ausführung (1x) - Ref. W394338-LB Tip seal "W4" version (1x) - Ref. W394338-LB		
---	------------------	--	--	--

4	W394339-LB	Dichtring "W4" Ausführung Diffusor seal "W4" version		
---	------------	---	--	--

**Type "S" - SAGOLA**

5	MA-AC-S-xxx-LB	Düse standard Ausführung Tip standard version		
	MA-AC-SF-xxx-LB	Düse mit Vorzerstäuber Tip with preorifice		

6	MA-AC-S-SEAL-LB	Düsendichtung "S" Ausführung (10x) Tip seal "S" version (10x)		
---	-----------------	--	--	--

# GUN, PUMP & SUCTION FILTER SYSTEMS

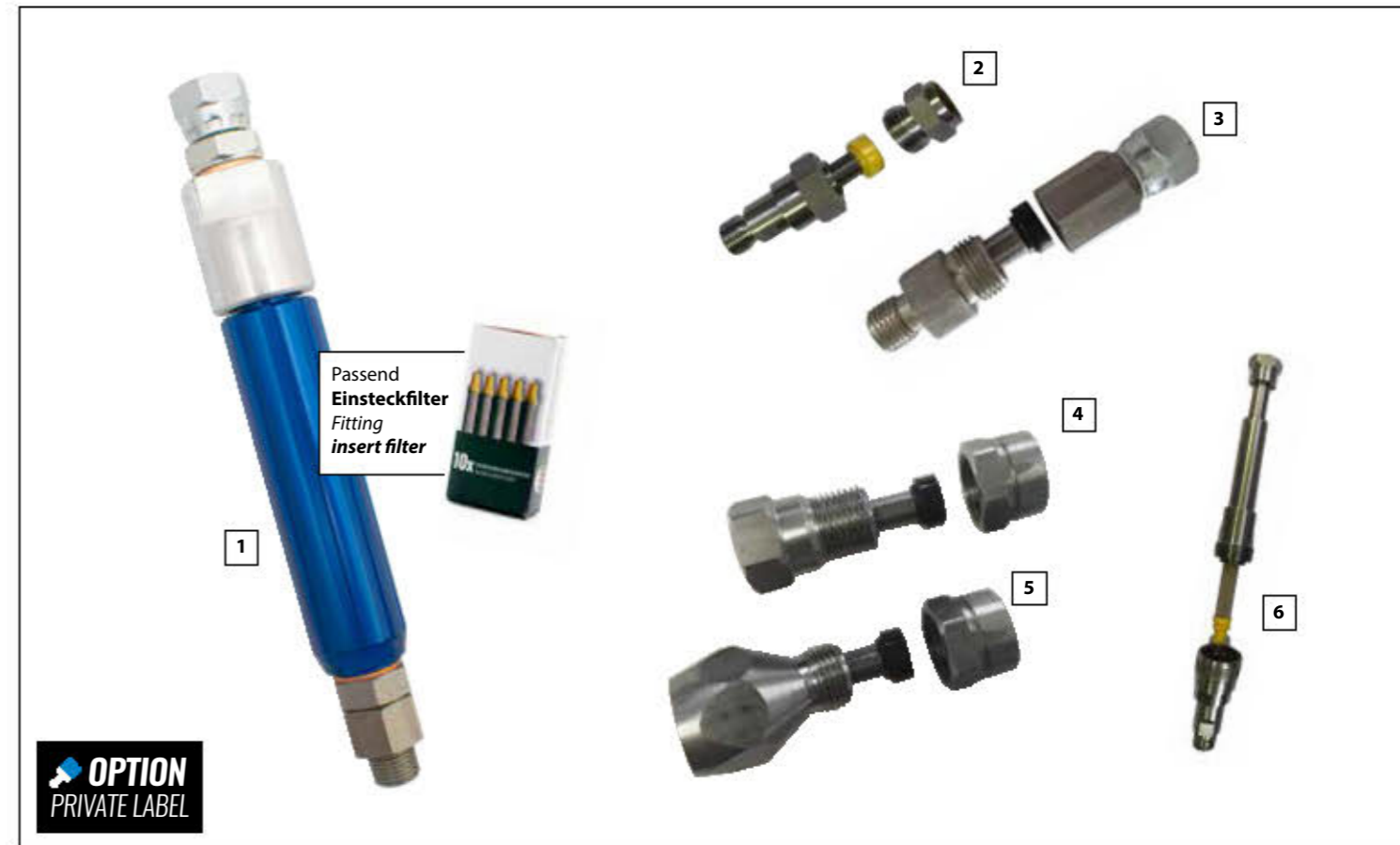

**OPTION**  
PRIVATE LABEL

### Filter-Gehäuse / Filter housing

Pos.	Art.-Nr. Part-No.	Artikelbeschreibung Description	Listenpreis List price €/Stück €/piece	Netto-Stückpreis bei Net unit price for
------	----------------------	------------------------------------	---	--

### Einsteckfilter Lang / Insert filter long

1	HOSE-FI-1/4-B	Schlauch-Filtergehäuse kompl. / Hose-filter housing cpl. - 1/4" BSP adapter alu		
	HOSE-FI-1/4-B-SS	Schlauch-Filtergehäuse kompl. / Hose-filter housing cpl. - 1/4" BSP adapter SS		

### SPALT filter

2	63004-BSP	Edelstahl / Stainless steel - Mini - 1/4" AG (M) - 1/4" IG (F) - BSP		
3	107300	Edelstahl / Stainless steel - 1/4" IG (F) - 1/4" AG (M) - NPS		
4	63006	Diffuser Filtergehäuse Edelstahl / Diffusor filter housing stainless steel - 11/16"		
5	63007	Diffuser Filtergehäuse Edelstahl / Diffusor filter housing stainless steel - 7/8"		

### Einsteckfilter Lang / Insert filter long

6	63001	Edelstahl / Stainless steel - 1/4" IG (F) - 1/4" AG (M) - BSP		
---	-------	---	--	--



**Pistolenfilter / Gun filter**

Pos.	Art.-Nr. Part-No.	Artikelbeschreibung Description	Listenpreis List price	Netto-Stückpreis bei Net unit price for
			€/Stück €/piece	

**Einsteckfilter / Insert filter**

1	HS34377-NEW	weiss - 50 Maschen / white - 50 mesh	<b>Mindestabnahme:</b> 10 Stk. = Verpackungseinheit  <b>Minimum order quantity:</b> 10 pcs. = packaging unit		
	HS43235-NEW	gelb - 100 Maschen / yellow - 100 mesh			
	HS34383-NEW	rot - 200 Maschen / red - 200 mesh			

2	HS89323-LB	grün - 30 Maschen / green - 30 mesh	<b>Mindestabnahme:</b> 10 Stk. = Verpackungseinheit  <b>Minimum order quantity:</b> 10 pcs. = packaging unit		
	HS34379-LB	schwarz - 70 Maschen / black - 70 mesh			
	HS34382-LB	blau - 150 Maschen / blue - 150 mesh			

3	77113	Feder / Spring			
			€/Stück €/piece		

4	W231-50-LB	weiss - 50 Maschen / white - 50 mesh	<b>Mindestabnahme:</b> 10 Stk. = Verpackungseinheit  <b>Minimum order quantity:</b> 10 pcs. = packaging unit		
	W231-100-LB	gelb - 100 Maschen / yellow - 100 mesh			
	W231-150-LB	blau - 150 Maschen / blue - 150 mesh			
	W231-200-LB	rot - 200 Maschen / red - 200 mesh			

**Einschraubfilter / Screw-in filter**

5	TIFI-60-LB	weiss - 60 Maschen / white - 60 mesh	<b>Mindestabnahme:</b> 10 Stk. = Verpackungseinheit  <b>Minimum order quantity:</b> 10 pcs. = packaging unit		
	TIFI-100-LB	gelb - 100 Maschen / yellow - 100 mesh			
	TIFI-150-LB	rot - 150 Maschen / red - 150 mesh			



**Pistolenfilter / Gun filter**

Pos.	Art.-Nr. Part-No.	Artikelbeschreibung Description	Listenpreis List price	Netto-Stückpreis bei Net unit price for
			€/Stück €/piece	

1	GR218-50-LB	blau - 50 Maschen / blue - 50 mesh	<b>Mindestabnahme:</b> 10 Stk. = Verpackungseinheit  <b>Minimum order quantity:</b> 10 pcs. = packaging unit		
	GR218-100-LB	orange - 100 Maschen / orange - 100 mesh			

2	GR287-60-LB	schwarz - 60 Maschen / black - 60 mesh	<b>Mindestabnahme:</b> 10 Stk. = Verpackungseinheit  <b>Minimum order quantity:</b> 10 pcs. = packaging unit		
	GR287-100-LB	blau - 100 Maschen / blue - 100 mesh			
	GR287-150-LB	orange - 150 Maschen / orange - 150 mesh			

**SPALT Filter Edelstahl / Stainless steel**

3	SPALT60-LB	weiss - 60 Maschen / white - 60 mesh	<b>Mindestabnahme:</b> 10 Stk. = Verpackungseinheit  <b>Minimum order quantity:</b> 10 pcs. = packaging unit		
	SPALT80-LB	blau - 80 Maschen / blue - 80 mesh			
	SPALT100-LB	schwarz - 100 Maschen / black - 100 mesh			
	SPALT200-LB	gelb - 200 Maschen / yellow - 200 mesh			

**Einschraubfilter / Screw-in filter**

4	HS82008-LB	weiß - 80 Maschen / white - 80 mesh	<b>Mindestabnahme:</b> 10 Stk. = Verpackungseinheit  <b>Minimum order quantity:</b> 10 pcs. = packaging unit		
	HS82016-LB	gelb - 150 Maschen / yellow - 150 mesh			
	HS82030-LB	rot - 295 Maschen / red - 295 mesh			



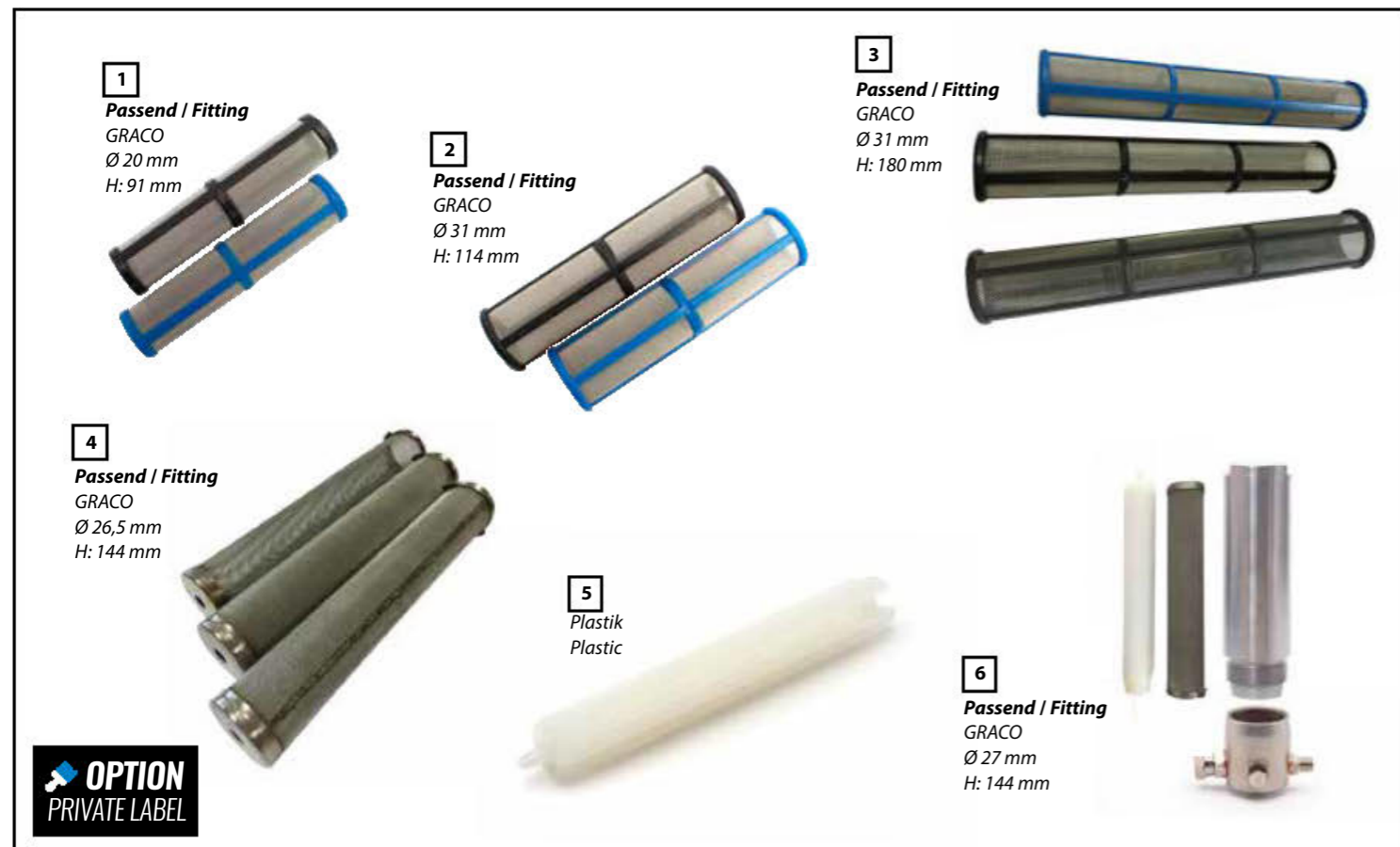

**Hochdruckfilter / High pressure filter typ "GR"**

Pos.	Art.-Nr. Part-No.	Artikelbeschreibung Description	Listenpreis List price	Netto-Stückpreis bei Net unit price for
			€/Stück €/piece	
1	GR246-60-LB	kurz - schwarz - 60 Maschen / short - black - 60 mesh		
	GR246-100-LB	kurz - blau - 100 Maschen / short - blue - 100 mesh		
2	GR243-60-LB	mittel - schwarz - 60 Maschen / medium - black - 60 mesh		
	GR243-100-LB	mittel - blau - 100 Maschen / medium - blue - 100 mesh		
3	GR244-30-LB	lang - grau - 30 Maschen / long - grey - 30 mesh		
	GR244-60-LB	lang - schwarz - 60 Maschen / long - black - 60 mesh		
	GR244-100-LB	lang - blau - 100 Maschen / long - blue - 100 mesh		
4	HDFG-15-LB	15 Maschen / 15 mesh - 144 mm		
	HDFG-30-LB	30 Maschen / 30 mesh - 144 mm		
	HDFG-60-LB	60 Maschen / 60 mesh - 144 mm		
	HDFG-80-LB	80 Maschen / 80 mesh - 144 mm		
	HDFG-100-LB	100 Maschen / 100 mesh - 144 mm		
	HDFG-150-LB	150 Maschen / 150 mesh - 144 mm		
	HDFG-200-LB	200 Maschen / 200 mesh - 144 mm		
5	3000-K	Filterstütze Plastik / Filter support plastic		

**Hochdruckfilter-Gehäuse / High pressure filter housing**

Pos.	Art.-Nr. Part-No.	Artikelbeschreibung Description	Listenpreis List price	Netto-Stückpreis bei Net unit price for
			€/Stück €/piece	
6	HP-FI-LO-N	3/8" NPS (F) - 1/4" NPS (M) Edelstahl ohne Filter und Stütze / Stainless steel without filter and support		



**Hochdruckfilter / High pressure filter typ "W"**

Pos.	Art.-Nr. Part-No.	Artikelbeschreibung Description	Listenpreis List price	Netto-Stückpreis bei Net unit price for
			€/Stück €/piece	
1	W351-20-LB	20 Maschen / 20 mesh - 144 mm		
	W351-50-LB	50 Maschen / 50 mesh - 144 mm		
	W351-100-LB	100 Maschen / 100 mesh - 144 mm		
	W351-200-LB	200 Maschen / 200 mesh - 144 mm		
2	W989-LB	Filterstütze / Filter support		
3	W508-30-LB	30 Maschen / 30 mesh - ProSpray		
	W508-60-LB	60 Maschen / 60 mesh - ProSpray		
	W508-100-LB	100 Maschen / 100 mesh - ProSpray		
4	T500-60-LB	Schwarz - 60 Maschen / black - 60 mesh		
	T500-100-LB	Weiß - 100 Maschen / white - 100 mesh		
5	W349-50-LB	50 Maschen / 50 mesh		

**Hochdruckfilter-Gehäuse / High pressure filter housing**

Pos.	Art.-Nr. Part-No.	Artikelbeschreibung Description	Listenpreis List price	Netto-Stückpreis bei Net unit price for
			€/Stück €/piece	
6	HP-FI-LO-N	3/8" NPS (F) - 1/4" NPS (M) Edelstahl ohne Filter und Stütze / Stainless steel without filter and support		
	HP-FI-LO-M	3/8" NPS (F) - M16x1.5 (M) Edelstahl ohne Filter und Stütze / Stainless steel without filter and support		



1

**Passend / Fitting**  
 Kremlin, Böllhoff, etc.  
 Ø 27 mm  
 H: 114 mm

2

Ø 21 mm  
 H: 114 mm

3

**Passend / Fitting**  
 Larius, Taiver  
 Ø 26,5 mm  
 H: 144 mm



**Hochdruckfilter / High pressure filter**

Pos.	Art.-Nr. Part-No.	Artikelbeschreibung Description	Listenpreis List price	Netto-Stückpreis bei Net unit price for
1	HDF02-LB	Nr. 2 - 200 Maschen / No. 2 - 200 mesh	€/Stück €/piece	
	HDF03-LB	Nr. 3 - 180 Maschen / No. 3 - 180 mesh		
	HDF04-LB	Nr. 4 - 165 Maschen / No. 4 - 165 mesh		
	HDF05-LB	Nr. 5 - 100 Maschen / No. 5 - 100 mesh		
	HDF06-LB	Nr. 6 - 80 Maschen / No. 6 - 80 mesh		
	HDF09-LB	Nr. 9 - 60 Maschen / No. 9 - 60 mesh		
	HDF12-LB	Nr. 12 - 50 Maschen / No. 12 - 50 mesh		
	HDF15-LB	Nr. 15 - 30 Maschen / No. 15 - 30 mesh		
2	FIU-S-LB	Filterstütze / Filter support		
3	HDF-L/T-30	Ohne Flügel - 30 Maschen / Without wings - 30 mesh		
	HDF-L/T-60	Ohne Flügel - 60 Maschen / Without wings - 60 mesh		
	HDF-L/T-100	Ohne Flügel - 100 Maschen / Without wings - 100 mesh		
	HDF-L/T-200	Ohne Flügel - 200 Maschen / Without wings - 200 mesh		



1

**Passend / Fitting**  
 WIWA  
 Ø 26 mm  
 H: 53 mm

2a

**Passend / Fitting**  
 WIWA  
 Ø 33,5 mm  
 H: 130 mm

2b

**Passend / Fitting**  
 WIWA  
 Ø 36,4 mm  
 H: 121 mm

3

**Passend / Fitting**  
 Binks, WIWA  
 Ø 32 mm  
 H: 61,5 mm

4

**Passend / Fitting**  
 Binks, WIWA  
 Ø 32 mm  
 H: 99,5 mm



**Hochdruckfilter / High pressure filter**

Pos.	Art.-Nr. Part-No.	Artikelbeschreibung Description	Listenpreis List price	Netto-Stückpreis bei Net unit price for
1	HDW-50-LB	orange - 50 Maschen / orange - 50 mesh	€/Stück €/piece	
	HDW-70-LB	gelb - 70 Maschen / yellow - 70 mesh		
	HDW-100-LB	schwarz - 100 Maschen / black - 100 mesh		
	HDW-150-LB	rot - 150 Maschen / red - 150 mesh		
	HDW-200-LB	weiss - 200 Maschen / white - 200 mesh		
2a	HDW162-30-LB	blau - 30 Maschen / blue - 30 mesh		
	HDW162-50-LB	orange - 50 Maschen / orange - 50 mesh		
	HDW162-70-LB	gelb - 70 Maschen / yellow - 70 mesh		
	HDW162-100-LB	schwarz - 100 Maschen / black - 100 mesh		
	HDW162-150-LB	rot - 150 Maschen / red - 150 mesh		
2b	HDW659-30-LB	blau - 30 Maschen / blue - 30 mesh		
	HDW659-50-LB	orange - 50 Maschen / orange - 50 mesh		
	HDW659-70-LB	gelb - 70 Maschen / yellow - 70 mesh		
	HDW659-100-LB	schwarz - 100 Maschen / black - 100 mesh		
	HDW659-150-LB	rot - 150 Maschen / red - 150 mesh		
3	HDH-II-50-LB	50 Maschen - Edelstahl / 50 mesh - stainless steel - TYP II		
	HDH-II-100-LB	100 Maschen - Edelstahl / 100 mesh - stainless steel - TYP II		
4	HDH-III-50-LB	50 Maschen - Edelstahl / 50 mesh - stainless steel - TYP III		
	HDH-III-100-LB	100 Maschen - Edelstahl / 100 mesh - stainless steel - TYP III		



**Ansaugfilter / Suction filter**

Pos.	Art.-Nr. Part-No.	Artikelbeschreibung Description	Listenpreis List price	Netto-Stückpreis bei Net unit price for
			€/Stück €/piece	
1	AF-H-15-xxx	15 Maschen / 15 Mesh - 1/2" / 3/4" / 1" / M28 / M38 - Hexagon		
	AF-H-30-xxx	30 Maschen / 30 Mesh - M28 - Hexagon		
2	ANF-R-15-xxx	15 Maschen / 15 Mesh - 1/2" / 3/4" / 7/8" / 1" / M15 / M28 - Round		
	ANF-R-15-3/4-UNF	15 Maschen / 15 Mesh - 3/4" UNF - Round (GR235004)		
	ANF-R-30-xxx	30 Maschen / 30 Mesh - 1/2" / 3/4" / 1" / M15 / M28 - Round		
	ANF-R-60-xxx	60 Maschen / 60 Mesh - 1/2" / M15 - Round		
3	ANF-MINI-1/2	30 Maschen / 30 Mesh - 1/2"		
	ANF-MINI-M15	30 Maschen / 30 Mesh - M15		
4	2011101	grob / rough - Ø 28		
	2011102	fein / smooth - Ø 28		
	2011103	grob / rough - Ø 22		
	2011104	fein / smooth - Ø 22		
5	AF-GR-7/8-LB	7/8" - ST MAX 395/495 (GR246385)		
	AF-GR-1-LB	1" - MARK/MAX (GR189920)		
6	W97531-LB	Filterbeutel / Filter bag - ca. 300 µ		

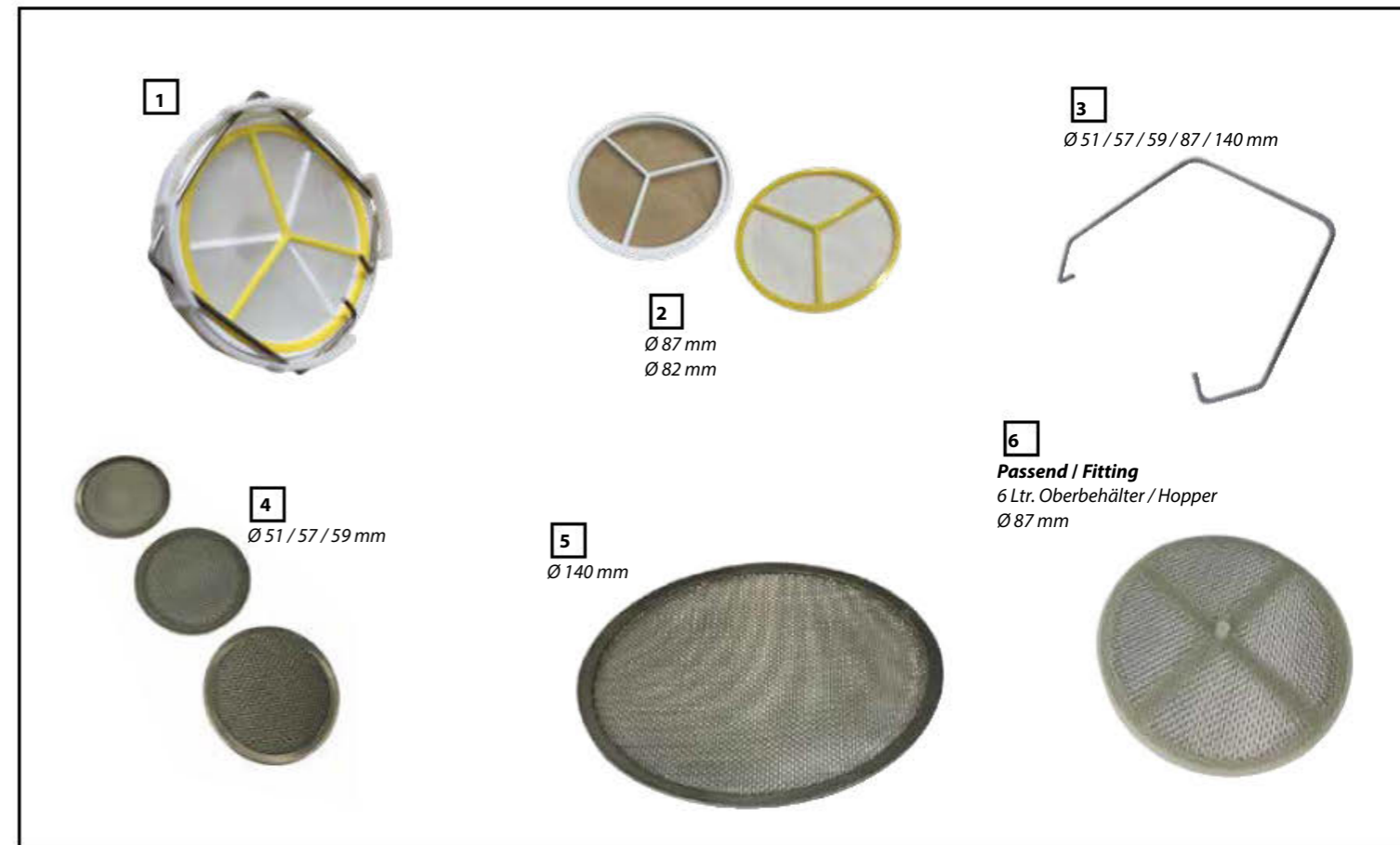

**Filterglocken & -scheiben / Suction housings & filter discs**

Pos.	Art.-Nr. Part-No.	Artikelbeschreibung Description	Listenpreis List price	Netto-Stückpreis bei Net unit price for
			€/Stück €/piece	
1	FG-KPL-M15-LB	Filterglocke kpl. / Filter housing cpl. - M15x1		
	FG-KPL-1/2-LB	Filterglocke kpl. / Filter housing cpl. - 1/2"		
2	FD-87-50-LB	Filterscheibe weiß / Filter disc white - D87 - 50 mesh		
	FD-82-100-LB	Filterscheibe gelb / Filter disc yellow - D82 - 100 mesh		
3	SR87-LB	Sprenging Edelstahl / Snap ring stainless steel		
4	FD-51-xx-LB	Filterscheibe - 20/40 Maschen - D51 Filter disc - 20/40 mesh - D51		
	FD-57-xx-LB	Filterscheibe - 20/40 Maschen - D57 Filter disc - 20/40 mesh - D57		
	FD-59-xx-LB	Filterscheibe Edelstahl 20/50 Maschen - D59 Filter disc stainless steel 20/50 mesh - D59		
5	FD-140-xx-LB	Filterscheibe Edelstahl - 20/50/70 Maschen - D140 Filter disc stainless steel - 20/50/70 mesh - D140		
3	SR-xx-LB	Sprenging Edelstahl / Snap ring stainless steel - D51/57/59		
	SR140-LB	Sprenging Edelstahl / Snap ring stainless steel - D140		
6	FI-HÜ	Filterscheibe 20 Maschen / Filter disc 20 mesh - D87 (6 ltr.)		



**1**  
Passend / Fitting  
Kremlin

**2**  
Passend / Fitting  
Kremlin

Pos.	Art.-Nr. Part-No.	Artikelbeschreibung Description	Listenpreis List price	Netto-Stückpreis bei Net unit price for
			€/Stück €/piece	
<b>Düsenfilter / Tip filter</b>				
1	KR-TIP-75-LB	Micro-Filter 75 Maschen (10x) Micro filter 75 mesh (10x)		
	KR-TIP-100-LB	Micro-Filter 100 Maschen (10x) Micro filter 100 mesh (10x)		
	KR-TIP-140-LB	Micro-Filter 140 Maschen (10x) Micro filter 140 mesh (10x)		
<b>Pistolenfilter / Gun filter</b>				
2	KR-4-85-LB	Ersatzfilter lang Nr. 6 - 85 Maschen (5x) Replacement filter long No. 6 - 85 mesh (5x)		
	KR-4-100-LB	Ersatzfilter lang - 100 Maschen (5x) Replacement filter long - 100 mesh (5x)		
	KR-4-140-LB	Ersatzfilter lang Nr. 4 - 140 Maschen (5x) Replacement filter long No. 4 - 140 mesh (5x)		



**1**  
Filtergehäuse  
Filter housing  
1/4"  
3/8"

**2**

**3**  
Passend / Fitting  
Fließbecher  
Gravity cup

Pos.	Art.-Nr. Part-No.	Artikelbeschreibung Description	Listenpreis List price	Netto-Stückpreis bei Net unit price for
			€/Stück €/piece	
<b>Niederdruck- und Becherfilter / Low pressure and cup filter</b>				
1	NDF-FG-1/4-LB	Delrin - 1/4" NPS (M) x 1/4" NPS (F)		
	NDF-FG-3/8-LB	Delrin - 3/8" NPS (M) x 3/8" NPS (F)		
	NDF-FG-3/8-SS-LB	Edelstahl / Stainless steel - 3/8" NPS (M) x 3/8" NPS (F)		
			€/Stück €/piece	
2	NDF-50-LB	Weiß - 50 Maschen / white - 50 mesh		
	NDF-110-LB	Blau - 110 Maschen / blue - 110 mesh		
	NDF-180-LB	Rot - 180 Maschen / red - 180 mesh		
	NDF-250-LB	Grün - 250 Maschen / green - 250 mesh		
3	35155-60-NY-LB	60 Maschen - Nylon / 60 mesh - Nylon		
	35155-60-SS-LB	60 Maschen - Edelstahl / 60 mesh - Stainless steel		
	35155-100-NY-LB	100 Maschen - Nylon / 100 mesh - Nylon		
	35155-100-SS-LB	100 Maschen - Edelstahl / 100 mesh - Stainless steel		

# HIGH PRESSURE PAINT SPRAY HOSES



**Stahlflecht**  
4x Sicherheitsfaktor  
**Wire braided**  
4x safety factor

## 1x Stahl / 1x Wire

Art.-Nr. Part.No.	Artikelbeschreibung Description	Listenpreis List price €/Stück €/piece	Netto-Stückpreis bei Net unit price for
W1-3/16-7.5-SS-NP	<b>Ø 3/16" - 7.5 Meter - 1/4" NPS</b> Arbeitsdruck 350 bar - Platzdruck 1.400 bar - Edelstahlanschlüsse Working pressure 350 bar - burst pressure 1.400 bar - stainless steel connections		
W1-1/4-10-SS-NP	<b>Ø 1/4" - 10 Meter - 1/4" NPS</b> Arbeitsdruck 275 bar - Platzdruck 1.100 bar - Edelstahlanschlüsse Working pressure 275 bar - burst pressure 1.100 bar - stainless steel connections		
W1-1/4-15-SS-NP	<b>Ø 1/4" - 15 Meter - 1/4" NPS</b> Arbeitsdruck 275 bar - Platzdruck 1.100 bar - Edelstahlanschlüsse Working pressure 275 bar - burst pressure 1.100 bar - stainless steel connections		
<b>2x Stahl / 2x Wire</b>			
H-W2-1/4-10-SS	<b>Ø 1/4" - 10 Meter - 1/4" NPS</b> Arbeitsdruck 450 bar - Platzdruck 1.800 bar - Edelstahlanschlüsse Working pressure 450 bar - burst pressure 1.800 bar - stainless steel connections		
H-W2-1/4-12-SS	<b>Ø 1/4" - 12 Meter - 1/4" NPS</b> Arbeitsdruck 450 bar - Platzdruck 1.800 bar - Edelstahlanschlüsse Working pressure 450 bar - burst pressure 1.800 bar - stainless steel connections		
H-W2-1/4-15	<b>Ø 1/4" - 15 Meter - 1/4" NPS</b> Arbeitsdruck 450 bar - Platzdruck 1.800 bar Working pressure 450 bar - burst pressure 1.800 bar		



**Textil / Textile**

Art.-Nr. Part-No.	Artikelbeschreibung Description	Listenpreis List price	Netto-Stückpreis bei Net unit price for	
		€/Stück €/piece	1 Stück 1 piece	
<b>Ø 1/8" / DN3</b>				
H-T-1/8-7.5-YE-SS	<b>Ø 1/8" - 7.5 Meter - 1/4" NPS</b> Arbeitsdruck 250 bar - Platzdruck 875 bar - Edelstahlanschlüsse - gelb Working pressure 250 bar - burst pressure 875 bar - stainless steel connections - yellow			
<b>Ø 3/16" / DN5</b>				
T-3/16-1.5-SS-NPE	<b>Ø 3/16" - 1.5 Meter - 1/4" NPS (F) x 1/4" NPS (M)</b> Arbeitsdruck 250 bar - Platzdruck 875 bar - Edelstahlanschlüsse - blau Working pressure 250 bar - burst pressure 875 bar - stainless steel connections - blue			
T-3/16-7.5-SS-NPE	<b>Ø 3/16" - 7.5 Meter - 1/4" NPS</b> Arbeitsdruck 250 bar - Platzdruck 875 bar - Edelstahlanschlüsse - blau Working pressure 250 bar - burst pressure 875 bar - stainless steel connections - blue			
T-3/16-7.5-YE-SS-NPE	<b>Ø 3/16" - 7.5 Meter - 1/4" NPS</b> Arbeitsdruck 250 bar - Platzdruck 875 bar - Edelstahlanschlüsse - gelb Working pressure 250 bar - burst pressure 875 bar - stainless steel connections - yellow			
T-3/16-10-SS-NPE	<b>Ø 3/16" - 10 Meter - 1/4" NPS</b> Arbeitsdruck 250 bar - Platzdruck 875 bar - Edelstahlanschlüsse - blau Working pressure 250 bar - burst pressure 875 bar - stainless steel connections - blue			
T-3/16-10-YE-SS-NPE	<b>Ø 3/16" - 10 Meter - 1/4" NPS</b> Arbeitsdruck 250 bar - Platzdruck 875 bar - Edelstahlanschlüsse - gelb Working pressure 250 bar - burst pressure 875 bar - stainless steel connections - yellow			
T-3/16-15-SS-NPE	<b>Ø 3/16" - 15 Meter - 1/4" NPS</b> Arbeitsdruck 250 bar - Platzdruck 875 bar - Edelstahlanschlüsse - blau Working pressure 250 bar - burst pressure 875 bar - stainless steel connections - blue			
T-3/16-15-YE-SS-NPE	<b>Ø 3/16" - 15 Meter - 1/4" NPS</b> Arbeitsdruck 250 bar - Platzdruck 875 bar - Edelstahlanschlüsse - gelb Working pressure 250 bar - burst pressure 875 bar - stainless steel connections - yellow			



**Textil / Textile**

Art.-Nr. Part-No.	Artikelbeschreibung Description	Listenpreis List price	Netto-Stückpreis bei Net unit price for	
		€/Stück €/piece		
<b>Ø 1/4" / DN6</b>				
T-1/4-1.5-SS-3-NPE	<b>Ø 1/4" - 1.5 Meter - 1/4" NPS (F) x 3/8" NPS (M)</b> Arbeitsdruck 260 bar - Platzdruck 920 bar - Edelstahlanschlüsse - blau Working pressure 260 bar - burst pressure 920 bar - stainless steel connections - blue			
T-1/4-1.5-SS-NPE	<b>Ø 1/4" - 1.5 Meter - 1/4" NPS (F) x 1/4" NPS (M)</b> Arbeitsdruck 260 bar - Platzdruck 920 bar - Edelstahlanschlüsse - blau Working pressure 260 bar - burst pressure 920 bar - stainless steel connections - blue			
T-1/4-15-SS-NPE	<b>Ø 1/4" - 15 Meter - 1/4" NPS</b> Arbeitsdruck 260 bar - Platzdruck 920 bar - Edelstahlanschlüsse - blau Working pressure 260 bar - burst pressure 920 bar - stainless steel connections - blue			
T-1/4-15-YE-SS-NPE	<b>Ø 1/4" - 15 Meter - 1/4" NPS</b> Arbeitsdruck 260 bar - Platzdruck 920 bar - Edelstahlanschlüsse - gelb Working pressure 260 bar - burst pressure 920 bar - stainless steel connections - yellow			
<b>Ø 3/8" / DN10</b>				
T-3/8-15-SS-NPE	<b>Ø 3/8" - 15 Meter - 3/8" NPS</b> Arbeitsdruck 260 bar - Platzdruck 920 bar - Edelstahlanschlüsse - blau Working pressure 260 bar - burst pressure 920 bar - stainless steel connections - blue			
T-3/8-30-SS-NPE	<b>Ø 3/8" - 30 Meter - 3/8" NPS</b> Arbeitsdruck 260 bar - Platzdruck 920 bar - Edelstahlanschlüsse - blau Working pressure 260 bar - burst pressure 920 bar - stainless steel connections - blue			
<b>Ø 1/2" / DN13</b>				
T-1/2-15-SS-NPE	<b>Ø 1/2" - 15 Meter - 1/2" NPS</b> Arbeitsdruck 260 bar - Platzdruck 920 bar - Edelstahlanschlüsse - blau Working pressure 260 bar - burst pressure 920 bar - stainless steel connections - blue			
MA-EF-1/2-15-SS	<b>Ø 1/2" - 15 Meter - 1/2" NPS - EASYFLEX</b> Sehr flexibel - Arbeitsdruck 260 bar - Platzdruck 920 bar - Edelstahlanschlüsse - blau Very flexible - working pressure 260 bar - burst pressure 920 bar - stainless steel connections - blue			



**HD-Material- und Luftschlauch / HP-material and air hose**

Pos.	Art.-Nr. Part-No.	Artikelbeschreibung Description	Listenpreis List price	Netto-Stückpreis bei Net unit price for
			€/Stück €/piece	
1	HTH-T-1/8-7.5-SS	1/8" - 7.5 m - 1/4" NPS - SS		
	HTH-T-3/16-7.5-SS	3/16" - 7.5 m - 1/4" NPS - SS		
	HTH-T-3/16-7.5M-SS	3/16" - 7.5 m - M16x1.5 - SS		
	HTH-T-3/16-7.5J-SS	3/16" - 7.5 m - 1/2" JIC - SS		
	HTH-T-3/16-10-SS	3/16" - 10 m - 1/4" NPS - SS		
	HTH-T-3/16-10M-SS	3/16" - 10 m - M16x1.5-SS		
	HTH-T-3/16-10J-SS	3/16" - 10 m - 1/2" JIC - SS		
	HTH-T-3/16-15-SS	3/16" - 15 m - 1/4" NPS - SS		
	HTH-T-3/16-15M-SS	3/16" - 15 m - M16x1.5-SS		
	HTH-T-3/16-15J-SS	3/16" - 15 m - 1/2" JIC - SS		
	HTH-T-3/16-20-SS	3/16" - 20 m - 1/4" NPS - SS		

**Luftschlauch / Air hose**

Pos.	Art.-Nr. Part-No.	Artikelbeschreibung Description	Listenpreis List price	Netto-Stückpreis bei Net unit price for
2	TPU20-6-AIR	6x10 mm - 20 bar Arbeitsdruck / working pressure (Rolle / Reel = 200 m)		

**Gewebeschutzschlauch / Protection hose**

Pos.	Art.-Nr. Part-No.	Artikelbeschreibung Description	Listenpreis List price	Netto-Stückpreis bei Net unit price for
3	GW30-S	24-36 mm (Rolle/Reel = 50/100/250 m)		
	GW40-S	32-47 mm (Rolle/Reel = 50/100 m)		



**Hochdruck Verbindungsrippel / High pressure nipples - 500 bar**

Pos.	Art.-Nr. Part-No.	Artikelbeschreibung Description	Listenpreis List price	Netto-Stückpreis bei Net unit price for
			€/Stück €/piece	

**Stahl / Steel**

1	M1/4NXM1/4N	1/4" NPS (M) x 1/4" NPS (M)		
	M1/4NXM1/4N-K	1/4" NPS (M) x 1/4" NPS (M) - konisch / conical		
	M1/4NXM3/8N	1/4" NPS (M) x 3/8" NPS (M)		
	M16XM1/4N	M16x1.5 (M) x 1/4" NPS (M)		
	M16XM16	M16x1.5 (M) x M16x1.5 (M)		
	M3/8NXM16	3/8" NPS (M) x M16x1.5 (M)		
	M3/8NXM3/8N	3/8" NPS (M) x 3/8" NPS (M)		

**Edelstahl / Stainless steel**

1	M1/4NXM1/4N-SS	1/4" NPS (M) x 1/4" NPS (M) - SS		
	M1/4NXM1/4N-K-SS	1/4" NPS (M) x 1/4" NPS (M) - konisch / conical - SS		
	M1/4NXM3/8N-SS	1/4" NPS (M) x 3/8" NPS (M) - SS		
	M16XM1/4N-SS	M16x1.5 (M) x 1/4" NPS (M) - SS		
	M16XM16-SS	M16x1.5 (M) x M16x1.5 (M) - SS		
	M3/8NXM16-SS	3/8" NPS (M) x M16x1.5 (M) - SS		
	M3/8NXM3/8N-SS	3/8" NPS (M) x 3/8" NPS (M) - SS		
	M3/8NXM1/2N-SS	3/8" NPS (M) x 1/2" NPS (M) - SS		
	M1/2NXM1/2N-SS	1/2" NPS (M) x 1/2" NPS (M) - SS		

# HEATING. MICRO. 4000.



**MICRO STEUERUNG!**

- Konstante Fix-Temperatur von 55°C unabhängig von Außentemperatur, Material und Düsengröße
- Sehr leichte Anwendung
- Direktanschluss an die Pumpe
- Kein separates Steuergerät/-kabel
- Einhaltung der VOC-Richtlinien
- Reduzierung der Viskosität
- Für wasser- und lösemittelhaltige Spritzmedien (Flammpunkt über 21°C)
- Auch für 2K-Materialien
- Adaptierbar an alle Airless-Geräte (Herstellervorgaben beachten)
- System steuert sich eigenständig – Keine Programmierung notwendig

**MICRO CONTROL!**

- Continual fix-temperature of 55°C independent of outside temperature, coating material and tip size
- Very easy to use
- Direct connection to the pump
- No separate control-unit/-cable
- In compliance with VOC-regulations
- Reduction of viscosity
- Suitable for solvent and water-based Material (flash point over 21°C)
- Also for 2-component material
- Adaptable to all Airless pumps (attend to manufacturer's specifications)
- System is independently self-controlled – No programming necessary

# HEATING. ADJUSTABLE. 3000.



**TEMPERATUR REGELBAR!**

- Beheiztes Schlauch-System passend für alle Airless-Geräte
- Stufenlose Temperaturregelung von 20°- 70°C
- Einhaltung der VOC-Richtlinien (Stufe 2)
- Erwärmung des Spritzmediums reduziert die Viskosität  
= Perfekte Beschichtung, auch an den Kanten  
= Weniger/keine Lösungsmittel notwendig  
= Wesentlich weniger Farbnebel  
= Erhöhung der Zerstäubungsqualität und des Auftragswirkungsgrades
- Geeignet auch für 2-Komponenten-Materialien
- Bessere Verarbeitung höhervisköser Beschichtungsmaterialien
- Für wasser- und lösemittelhaltige Spritzmedien (Flammpunkt über 21°C)
- Beheiztes Schlauch-System ermöglicht den Einsatz kleinerer Airless-Pumpen und somit weniger Anschaffungs- und Betriebskosten

**TEMPERATURE ADJUSTABLE!**

- Heated hose system adaptable to all Airless pumps
- Infinitely adjustable temperature 20°- 70°C
- In compliance with VOC-regulations (level 2)
- Heating of material reduces viscosity of paint drastically  
= Vastly improved coating-results, even at edges  
= Little/no solvent needed to be added to paint  
= Reduced overspray  
= Increasing of diffusion quality and the application result
- Suitable for 2-component materials
- Better processing of high viscosity coating materials
- Suitable for solvent and water-based materials (flash point over 21°C)
- Heated hose system reduces the need for larger Airless units which means less investment, less expenses

**Heizschlauchserie MICRO 4000 / Heated hose series MICRO 4000 - 250 bar**

Art.-Nr. Part-No.	Artikelbeschreibung Description	Listenpreis List price	Netto-Stückpreis bei Net unit price for
		€/Stück €/piece	
G-HH-7.5-55	Textil / Textile - 5/16" - 55°C - 7,5 m		
G-HH-15-55	Textil / Textile - 3/8" - 55°C- 15 m		

**Heizschlauchserie 3000 / Heated hose series 3000 - 250 bar**

Art.-Nr. Part-No.	Artikelbeschreibung Description	Listenpreis List price	Netto-Stückpreis bei Net unit price for
		€/Stück €/piece	
G-HH-T-7.5-5/16	Textil / Textile - 5/16" - 7.5 m		
G-HH-T-15	Textil / Textile - 3/8" - 15 m		
G-HH-T-30	Textil / Textile - 3/8" - 30 m		



# LIQUIDS & CLEANING PRODUCTS

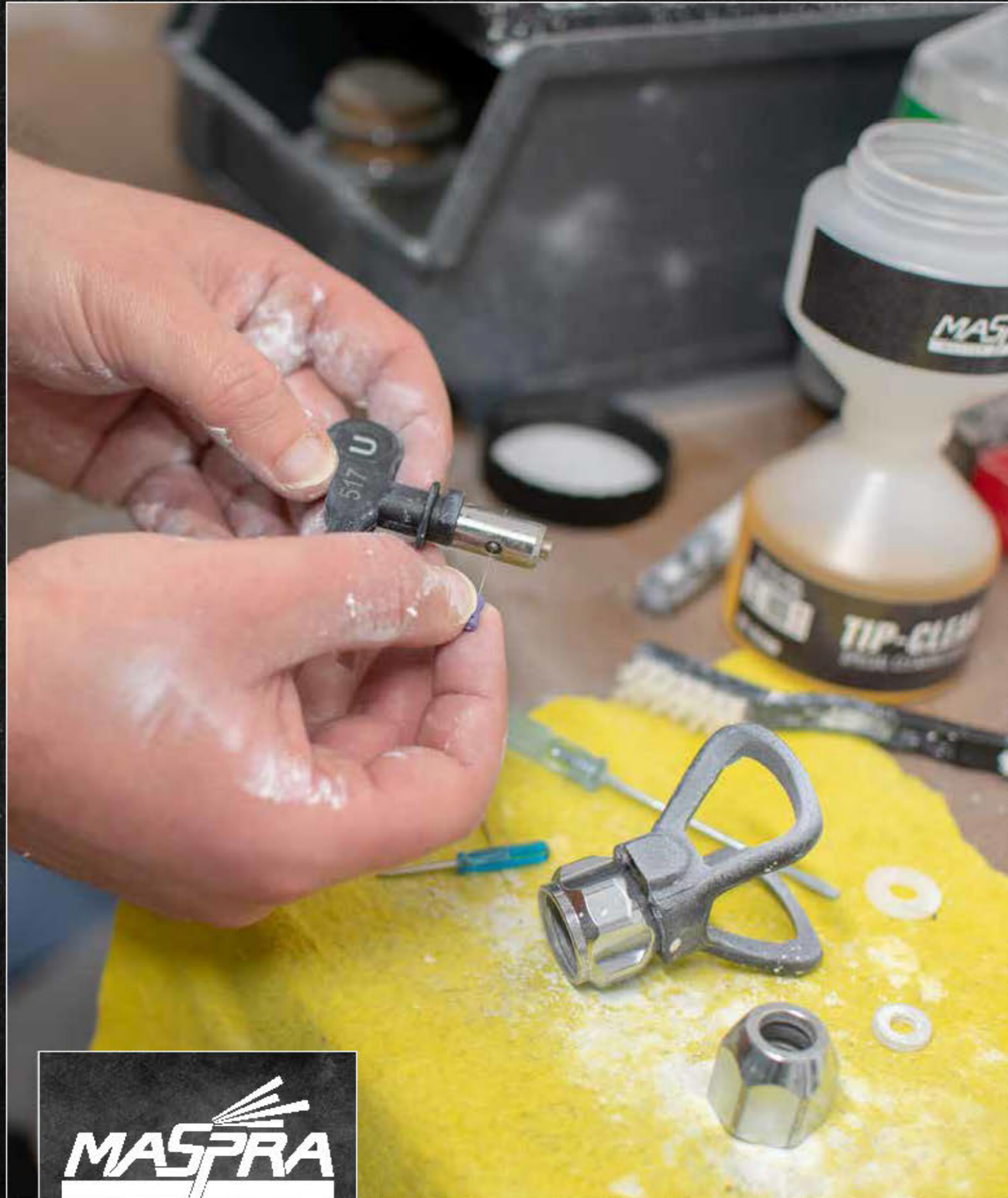

Art.-Nr. / Part-No.  
**MA-TC200**

**MASPRA Tip-Clean  
Reinigungsflüssigkeit**

- Einfache und schnelle  
Reinigung ohne Haut-  
kontakt
- 200 ml

**MASPRA Tip-Clean  
cleaning liquid**

- Easy and fast cleaning  
without skin contact
- 200 ml



Art.-Nr. / Part-No.  
**MA-TC200-24**

**MASPRA Tip-Clean  
in der 24er Box**

- 24x 200 ml

**MASPRA Tip-Clean  
in a box of 24 pieces**

- 24x 200 ml



Art.-Nr. / Part-No.  
**MA-TC1000**

**MASPRA Tip-Clean  
Reinigungsflüssigkeit**

- Nachfüllflasche
- 1.000 ml

**MASPRA Tip-Clean  
cleaning liquid**

- Refill bottle
- 1.000 ml



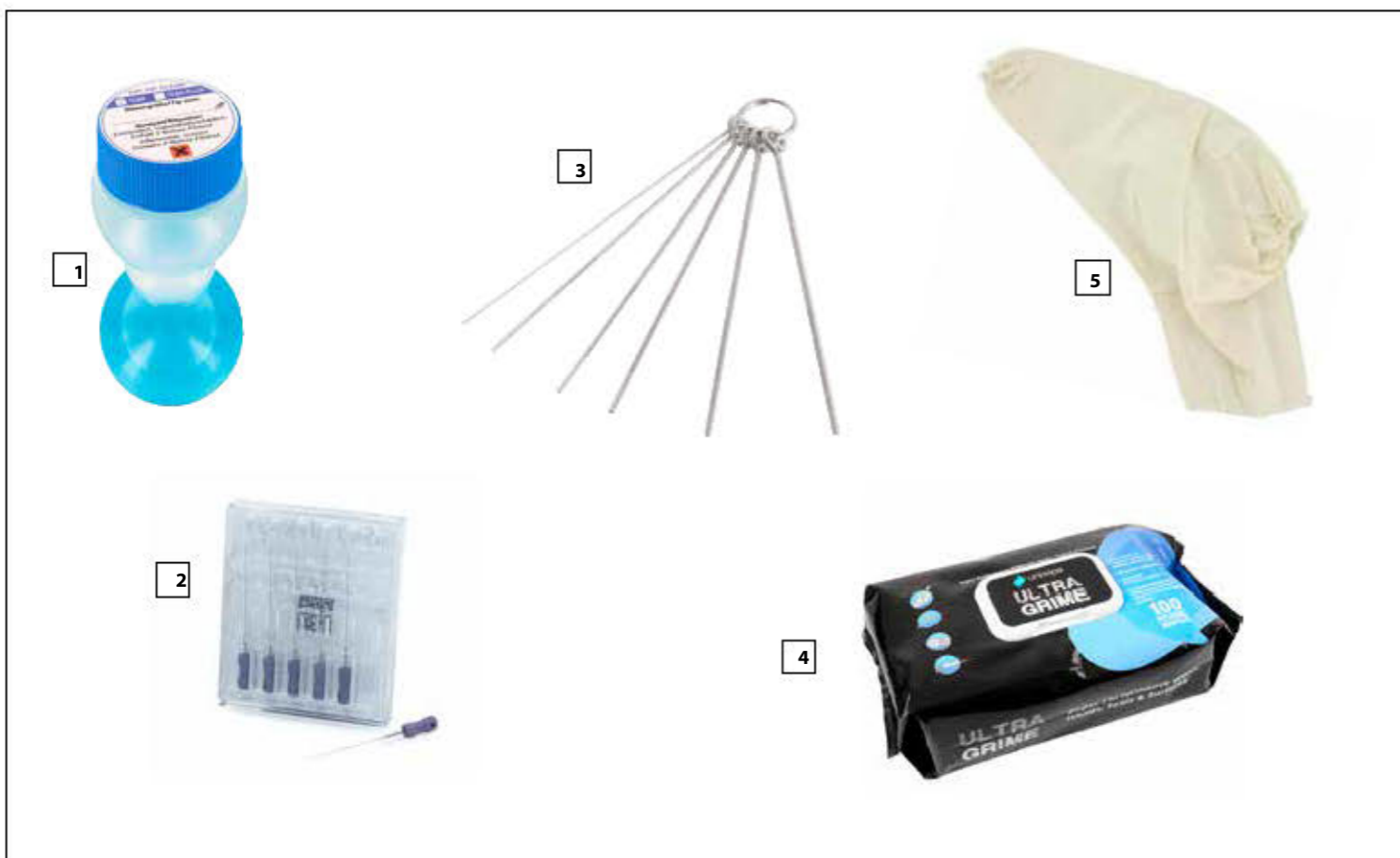

Pos.	Art.-Nr. Part-No.	Artikelbeschreibung Description	Listenpreis List price	Netto-Stückpreis bei Net unit price for
			€/Stück €/piece	

**Düsenreinigung / TIP cleaning**

1	TC50	TIP-Clean - 50 ml		
---	------	-------------------	--	--

**Reinigungsnadeln / Cleaning broaches**

2	DRN-10/31-6	Ø10 / L 31 mm (6x)		
3	B-NS6	Ring mit 6 Nadeln / Ring with 6 broaches		

**ULTRA GRIME**

4	ULTRA-G	Reinigungstücher für Hände, Werkzeuge und Oberflächen Cleaning wipes for hands, tools and surfaces		
---	---------	---	--	--

**Pistolenschutz E-Statik / Gun cover e-static**

5	ESTA-WA-LB	Handschuh / Glove		
	ESTA-100	Handschuh / Glove - TYVEK		



Art.-Nr. / Part-No.  
**MA-TM-05**  
**MASPRA Mesamoll  
Throat Sealing Liquid**  
Trennmittel - 500 ml  
Separating fluid - 500 ml



Art.-Nr. / Part-No.  
**MA-TM-5000**  
**MASPRA Mesamoll  
Throat Sealing Liquid**  
Trennmittel - 5.000 ml  
Separating fluid - 5.000 ml



Art.-Nr. / Part-No.  
**GR245423**  
**ASM Pump Life  
1.000 ml**  
Konservierungsmittel  
Preserving agent



Art.-Nr. / Part-No.  
**GR245425**  
**ASM oil  
1.000 ml**  
Hydrauliköl  
Hydraulic fluid





Pos.	Art.-Nr. Part-No.	Artikelbeschreibung Description	Listenpreis List price	Netto-Stückpreis bei Net unit price for
			€/Stück €/piece	

**Bürsten / Brushes**

1	B-SB5	Bürstenreinigungs-Set 5 teilig Brush cleaning set 5 parts		
2	B-001	Reinigungsbürste / Cleaning brush		
3	B-10	Reinigungsbürste - 300 mm - 100 mm - 15 mm Cleaning brush - 300 mm - 100 mm - 15 mm		
	B-11	Reinigungsbürste - 155 mm - 55 mm - 10 mm Cleaning brush - 155 mm - 55 mm - 10 mm		
	B-12	Reinigungsbürste - 230 mm - 80 mm - 12 mm Cleaning brush - 230 mm - 80 mm - 12 mm		
	B-13	Reinigungsbürste - 155 mm - 55 mm - 10 mm - konisch Cleaning brush - 155 mm - 55 mm - 10 mm - conical		
4	B-14	Reinigungspinsel / Cleaning brush		

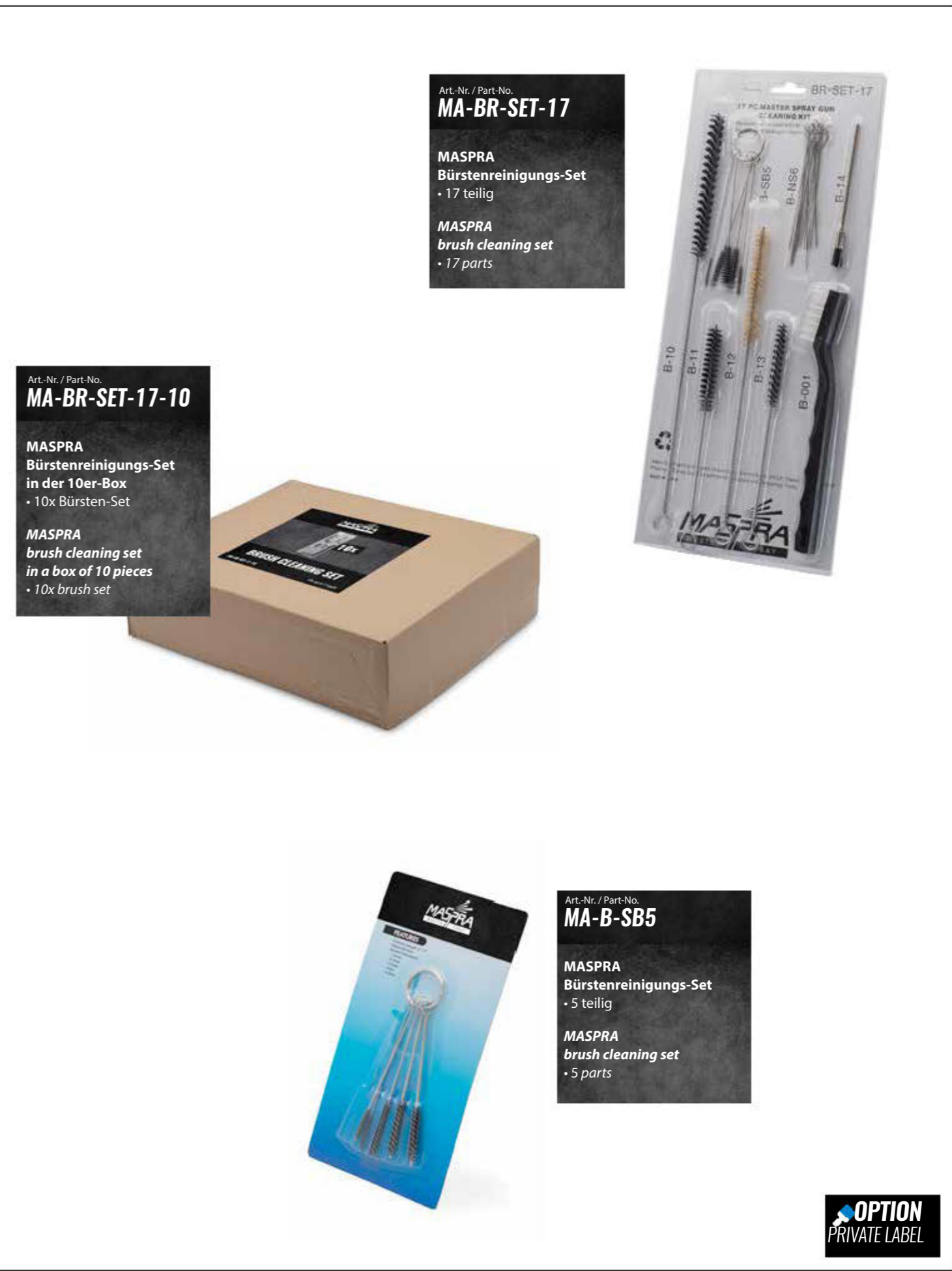

Art.-Nr. / Part-No.  
**MA-BR-SET-17**  
**MASPRA**  
Bürstenreinigungs-Set  
• 17 teilig  
**MASPRA**  
brush cleaning set  
• 17 parts

Art.-Nr. / Part-No.  
**MA-BR-SET-17-10**  
**MASPRA**  
Bürstenreinigungs-Set  
in der 10er-Box  
• 10x Bürsten-Set  
**MASPRA**  
brush cleaning set  
in a box of 10 pieces  
• 10x brush set

Art.-Nr. / Part-No.  
**MA-B-SB5**  
**MASPRA**  
Bürstenreinigungs-Set  
• 5 teilig  
**MASPRA**  
brush cleaning set  
• 5 parts

Art.-Nr. / Part-No.

**MA-KIT-AL****MASPPRA Kit "Airless"**

- Universal Tragetasche
- Airless Pistole 500 bar - 7/8"
- HD-Schlauch 1/4" - 15 m
- Schlauchpeitsche 3/16" - 1.5 m
- MASPPRA Universal Düsenhalter & Düsen (411 & 521)
- Düsenverlängerung 30 cm & Kniegelenk
- Je 10x Einsteckfilter gelb, rot & weiß
- TIP-Clean 200 ml

**MASPPRA kit "Airless"**

- Universal shoulder bag
- Airless gun 500 bar - 7/8"
- HP-hose 1/4" - 15 m
- Hose whip 3/16" - 1.5 m
- MASPPRA Universal tip base & tips (411 & 521)
- Pole extension 30 cm & angle head
- Gun filter yellow, red & white (10 of each)
- TIP-Clean 200 ml



Art.-Nr. / Part-No.

**MA-KIT-AL-TUBE****MASPPRA Kit "Innenbeschichtung"**

- Universal Tragetasche
- Airless Pistole 250 bar - 7/8"
- HD-Schlauch 3/16" - 7.5 m
- Aufnahmeadapter 7/8"
- Flexible Verlängerung 80 cm
- Rundstrahlöse R11

**MASPPRA kit "tube coating"**

- Universal shoulder bag
- Airless gun 250 bar - 7/8"
- HP-hose 3/16" - 7.5 m
- Adapter 7/8"
- Flexible tube 80 cm
- Round jet tip R11

Art.-Nr. / Part-No.

**MA-KIT-AC****MASPR Kit "AirCombi"**

- Universal Tragetasche
- AirCombi Pistole 250 bar mit blauer Luftkappe & Düse "W" 411
- Langes Filtergehäuse
- AirCombi Schlauch 3/16" - 7.5 m
- Rote Luftkappe & Düse "W" 513
- Je 10x Einsteckfilter gelb & rot
- TIP-Clean 50 ml

**MASPR kit "AirCombi"**

- Universal shoulder bag
- AirCombi gun 250 bar with blue AirCap & tip "W" 411
- Long filter housing
- AirCombi hose 3/16" - 7.5 m
- Red AirCap & tip "W" 513
- Gun filter yellow & red (10 of each)
- TIP-Clean 50 ml



Art.-Nr. / Part-No.

**MA-KIT-CLEAN****MASPR Kit "Reinigung"**

- Universal Tragetasche
- Einwegoverall Gr. XXL
- 5x Schutzmaske KN95 (FFP2)
- Reinigungstücher
- TIP-Clean 200 ml
- Reinigungslösung 1.000 ml
- Trennmittel 500 ml
- Bürstenreinigungs-Set 17 tlg.

**MASPR kit "cleaning"**

- Universal shoulder bag
- Single use overall size XXL
- 5x face mask KN95 (FFP2)
- Cleaning wipes
- TIP-Clean 200 ml
- Cleaning liquid 1.000 ml
- Separating fluid 500 ml
- Brush cleaning set 17 parts



Art.-Nr. / Part-No.

**MA-KIT-AIR-210****MASPPA Kit "Air 210"**

- Universal Tragetasche
- Luftpistole mit Düse & Nadel 1.5 mm
- Luftkappe, Düse & Nadel 2.5 mm
- Niederdruck-Tandemschlauch 7.5 m
- Filtergehäuse
- Je 10x Filter blau & weiß
- Bürstenreinigungs-Set 5 tlg.

**MASPPA kit "Air 210"**

- Universal shoulder bag
- Air gun with nozzle & needle 1.5 mm
- AirCap, nozzle & needle 2.5 mm
- Low pressure twin hose 7.5 m
- Filter housing
- Filter blue & white (10 of each)
- Brush cleaning set 5 parts



Art.-Nr. / Part-No.

**MA-KIT-AIR-413****MASPPA Kit "Air 413"**

- Universal Tragetasche
- Luftpistole mit Düse & Nadel 1.5 mm
- Luftkappe, Düse & Nadel 2.5 mm
- Fließbecher 600 ml
- Schnellkupplung 1/4"
- Luftregelventil mit Manometer 1/4"
- 10x Filter für Fließbecher
- 25x Einfülltrichter inkl. Filter
- Bürstenreinigungs-Set 5 tlg.

**MASPPA kit "Air 413"**

- Universal shoulder bag
- Air gun with nozzle & needle 1.5 mm
- AirCap, nozzle & needle 2.5 mm
- Gravity cup 600 ml
- Quick coupling 1/4"
- Air flow control valve with gauge 1/4"
- 10x Filter for gravity cup
- 25x Feed hopper with sieve
- Brush cleaning set 5 parts



**PRONA**  
Drucktanks / Pressure pots  
122 - 125



**ASM**  
142 - 145

**PRONA**  
Doppelmembranpumpen / Double diaphragm pumps  
126 - 127



**GRACO CED**  
146 - 149

**PRONA**  
Pneumatische Rührwerke / Pneumatic agitators  
128 - 131



**GRACO Heavy Duty**  
150 - 151

**PRONA**  
Luftpistolen / Air guns  
132 - 135



**GRACO Finishing**  
152 - 155

**PRONA**  
Automatik Pistolen / Automatic guns  
136 - 137



**WAGNER**  
156 - 157

**AIRGUNSA & ANEST IWATA**  
Luftpistolen / Air guns  
138 - 139



**WIWA & KREMLIN**  
158 - 159

**Niederdruck Zubehör**  
Low pressure accessories  
140 - 141



**FORMECO**  
160 - 161

# PRONA. TANKS.

## Drucktanks aus Aluminium oder Edelstahl.

- Erhältlich in 2/5/10/20/40/60 Ltr.
- Mit pneumatischem, manuellem oder ohne Rührwerk
- Inkl. Edelstahl Einsatztopf (ab 5 Ltr.)
- Bis max. 3 bar (mit Sicherheitsventil)
- Fahrbar durch einklappbare Räder (nur Alu Version ab 10 Ltr.)
- Manometer für Materialspritzdruck

## Pressure tanks made of aluminium or stainless steel.

- Available in 2/5/10/20/40/60 Ltr.
- With pneumatic, manual or without agitator
- Incl. stainless steel inner tank (for 5 ltr. and more)
- Up to max. 3 bar (with safety valve)
- Mobile by the use of foldable tires (only alu version starting from 10 ltr.)
- Gauge for material pressure



### PRONA

Art.-Nr. Part-No.	Artikelbeschreibung Description	Listenpreis List price	Netto-Stückpreis bei Net unit price for
		€/Stück €/piece	

### Drucktanks - Aluminium / Pressure tanks - aluminum

#### 2 Liter

RT-2E	Aluminium - 2 Ltr. - Hakengriff / Handle hook		
RC-2E	Aluminium - 2 Ltr. - Rundgriff / Handle round		



### PRONA

Art.-Nr. Part-No.	Artikelbeschreibung Description	Listenpreis List price	Netto-Stückpreis bei Net unit price for
		€/Stück €/piece	

### Drucktanks - Aluminium / Pressure tanks - aluminum

#### 5 Liter

RT-5E	ohne Rührwerk / without agitator - 5 Ltr.		
RT-5M	mit manuellem Rührwerk / with manual agitator - 5 Ltr.		
RT-5A	mit pneumatischem Rührwerk / with pneumatic agitator - 5 Ltr.		

#### 10 Liter

RT-10E	ohne Rührwerk / without agitator - 10 Ltr.		
RT-10M	mit manuellem Rührwerk / with manual agitator - 10 Ltr.		
RT-10A	mit pneumatischem Rührwerk / with pneumatic agitator - 10 Ltr.		

#### 20 Liter

RT-20E	ohne Rührwerk / without agitator - 20 Ltr.		
RT-20M	mit manuellem Rührwerk / with manual agitator - 20 Ltr.		
RT-20A	mit pneumatischem Rührwerk / with pneumatic agitator - 20 Ltr.		

#### 40 Liter

RT-40E	ohne Rührwerk / without agitator - 40 Ltr.		
RT-40A	mit pneumatischem Rührwerk / with pneumatic agitator - 40 Ltr.		

#### 60 Liter

RT-60E	ohne Rührwerk / without agitator - 60 Ltr.		
RT-60A	mit pneumatischem Rührwerk / with pneumatic agitator - 60 Ltr.		





**CE** **ATEX** **max. 3 bar**

**PRONA**

Art.-Nr. Part-No.	Artikelbeschreibung Description	Listenpreis List price	Netto-Stückpreis bei Net unit price for
		€/Stück €/piece	

**Drucktanks - Edelstahl / Pressure tanks - stainless steel**

**5 Liter**

RT-5ES	ohne Rührwerk / without agitator - 5 Ltr.		
RT-5AS	mit pneumatischem Rührwerk / with pneumatic agitator - 5 Ltr.		

**10 Liter**

RT-10ES	ohne Rührwerk / without agitator - 10 Ltr.		
RT-10AS	mit pneumatischem Rührwerk / with pneumatic agitator - 10 Ltr.		

**20 Liter**

RT-20AS	mit pneumatischem Rührwerk / with pneumatic agitator - 20 Ltr.		
---------	--	--	--

**40 Liter**

RT-40AS	mit pneumatischem Rührwerk / with pneumatic agitator - 40 Ltr.		
---------	--	--	--

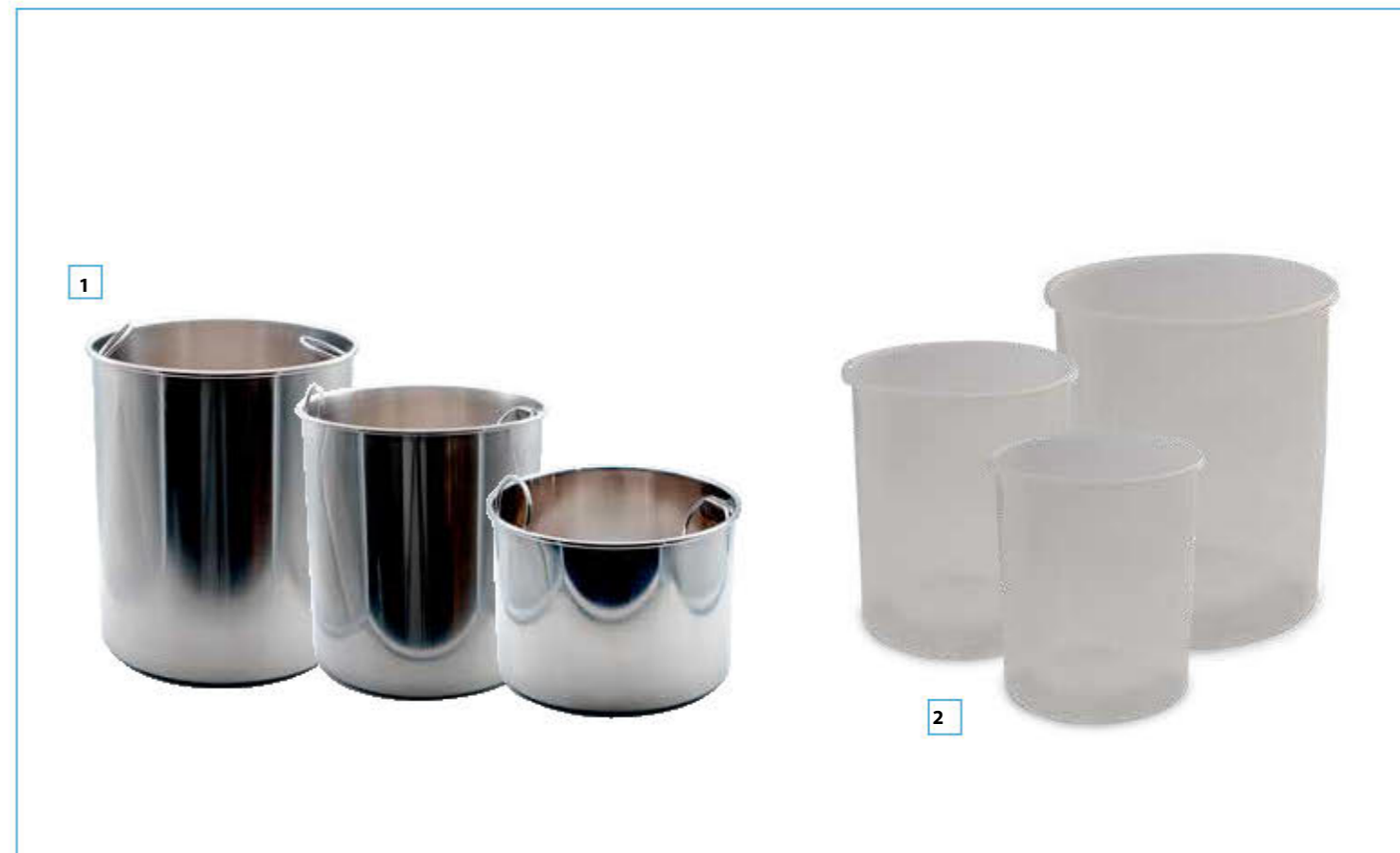

**PRONA**

Pos.	Art.-Nr. Part-No.	Artikelbeschreibung Description	Listenpreis List price	Netto-Stückpreis bei Net unit price for
			€/Stück €/piece	

**Einsatzbehälter - Edelstahl / Inner tank - stainless steel**

1	RT-IT-5-SS	5 Ltr.		
	RT-IT-10-SS	10 Ltr.		
	RT-IT-20-SS	20 Ltr.		
	RT-IT-40-SS	40 Ltr.		
	RT-IT-60-SS	60 Ltr.		

**Einweg Plastik-Einsatz / Disposable plastic bag**

2	RT-10#2-2	10 Ltr. (1 Stück / 1 piece)		
	RT-20#2-2	20 Ltr. (1 Stück / 1 piece)		
	RT-40#2-2	40 Ltr. (1 Stück / 1 piece)		
	RT-60#2-2	60 Ltr. (1 Stück / 1 piece)		

# PRONA. PUMPS.

## Pneumatische Doppelmembranpumpen

- Erhältlich aus Aluminium, Polypropylen oder Edelstahl
- Von 36 bis zu 580 Ltr./Min.
- 3/8" bis zu 2"

## Pneumatic double diaphragm pumps

- Available made of aluminum, polypropylene or stainless steel
- From 36 up to 580 ltr./min.
- From 3/8" up to 2"



**1**  
Aluminium



**2**  
Polypropylene



**3**  
Edelstahl  
Stainless steel

### PRONA

Pos.	Art.-Nr. Part-No.	Artikelbeschreibung Description	Listenpreis List price	Netto-Stückpreis bei Net unit price for
			€/Stück €/piece	

### Aluminium / Aluminium

1	R-15	3/8" – 36 Ltr./min. – Aluminium		
	R-20	1/2" – 50 Ltr./min. – Aluminium		
	R-31	1" – 180 Ltr./min. – Aluminium		
	R-41	1 1/2" – 300 Ltr./min. – Aluminium		
	R-51	2" – 580 Ltr./min. – Aluminium		

### Polypropylene / Polypropylene

2	PP-20	1/2" – 50 Ltr./min. – Polypropylene		
---	-------	-------------------------------------	--	--

**4** PRONA  
R-15 Set



**6** UNIVERSAL  
Fahrwagen  
Trolley



**5** PRONA  
R-1500-PLUS



**7**  
Aluminium



**8**  
Edelstahl  
Stainless steel



### PRONA

Pos.	Art.-Nr. Part-No.	Artikelbeschreibung Description	Listenpreis List price	Netto-Stückpreis bei Net unit price for
			€/Stück €/piece	
<b>Edelstahl / Stainless steel</b>				
3	RS-15-SS	3/8" – 36 Ltr./min. – Edelstahl / stainless steel		
	RS-20-SS	1/2" – 50 Ltr./min. – Edelstahl / stainless steel		
	RS-31-SS	1" – 180 Ltr./min. – Edelstahl / stainless steel		
	RS-41-SS	1 1/2" – 300 Ltr./min. – Edelstahl / stainless steel		
	RS-51-SS	2" – 580 Ltr./min. – Edelstahl / stainless steel		

### SprayPacks

4	R-1500	R-15 Pumpe inkl. Ansaugsystem - Auf Ständer R-15 Pump incl. suction system - on stand		
5	R-1500-PLUS	R-15 Pumpe inkl. Ansaugsystem & Rührwerk - Auf Ständer R-15 Pump incl. suction system & agitator - on stand		

### Zubehör / Accessories

6	R-T-DDP	Universal Fahrwagen inkl. Aufnahme für Doppelmembranpumpen Universal trolley incl. support for double diaphragm pumps		
7	RPR-5	Materialdruckregler - 3/8" - 0-6 bar - 2 Ltr./min. Fluid regulator - 3/8" - 0-6 bar - 2 Ltr./min.		
8	RPR-5-SS	Materialdruckregler - 3/8" - 0-6 bar - 2 Ltr./min. - Edelstahl Fluid regulator - 3/8" - 0-6 bar - 2 Ltr./min. - stainless steel		

# PRONA. AGITATORS.

## Pneumatische Rührwerke

- Für Gebinde bis 200 Liter
- Von 60 bis zu 370 Watt
- Von 1.420 bis 3.000 U/min

## Pneumatic agitators

- For compound units up to 200 liters
- From 60 up to 370 watts
- From 1.420 up to 3.000 RPM



PRONA				
Pos.	Art.-Nr. Part-No.	Artikelbeschreibung Description	Listenpreis List price	Netto-Stückpreis bei Net unit price for
			€/Stück €/piece	
Mini				
1	RB-MN	Mini Rührwerk - max. 10 Ltr. Gebinde Mini agitator - max. 10 ltr. compound units		
2	RB-MN-1A	Mini Rührwerk - max. 10 Ltr. Gebinde - inkl. Universal Adapter Mini agitator - max. 10 ltr. compound units - incl. universal adapter		

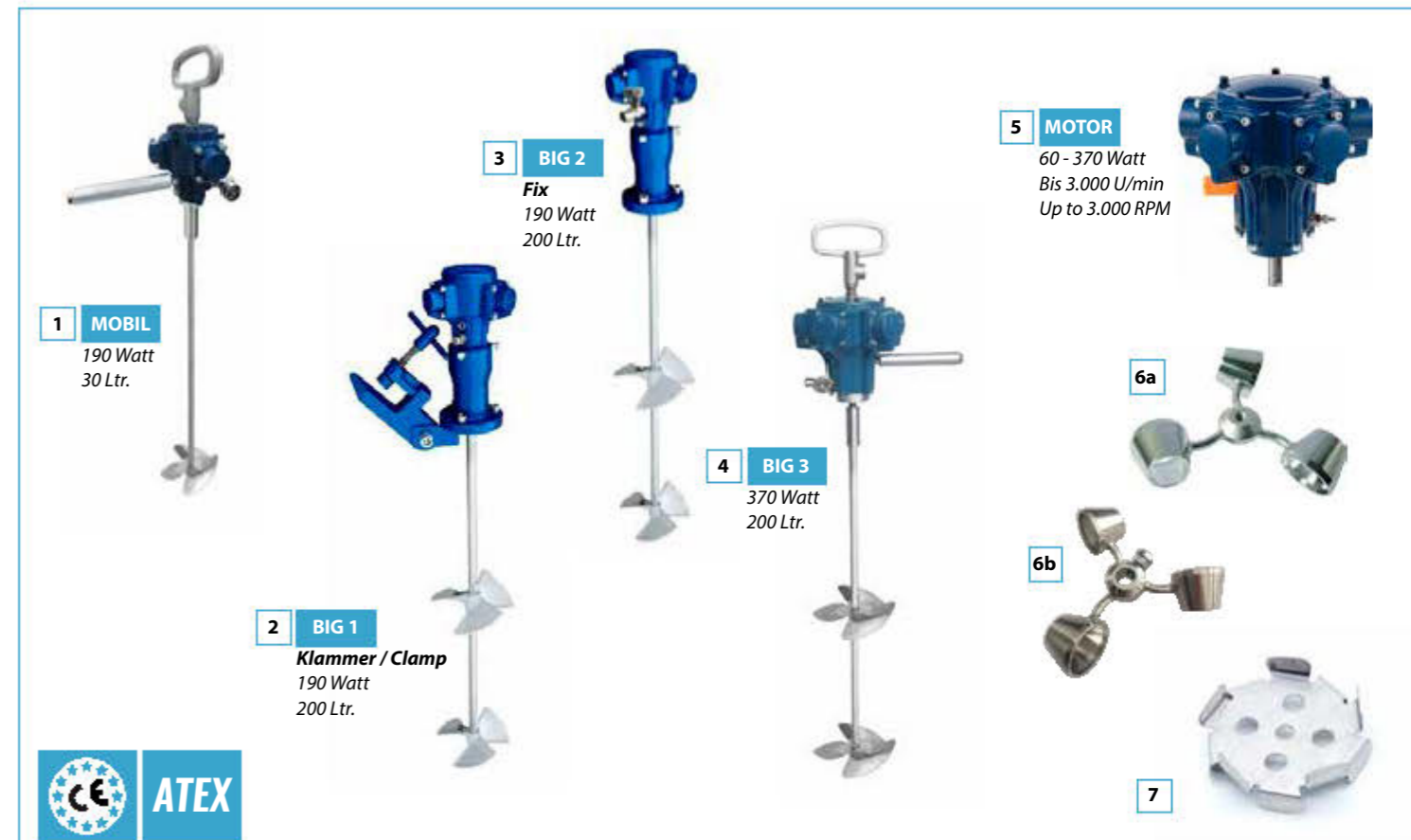

PRONA				
Pos.	Art.-Nr. Part-No.	Artikelbeschreibung Description	Listenpreis List price	Netto-Stückpreis bei Net unit price for
			€/Stück €/piece	
Mobil				
1	RB-MA	Mobiles Handrührwerk - max. 30 Ltr. Gebinde Mobile hand agitator - max. 30 ltr. compound units		
Big				
2	RB-200-KLEMM	Rührwerk inkl. Klemmbefestigung - 200 Ltr. Gebinde - M30 Motor Agitator with clamp fixation - 200 ltr. compound units - M30 motor		
3	RB-200-FIX	Rührwerk mit FIX Befestigung - 200 Ltr. Gebinde - M30 Motor Agitator with fixation - 200 ltr. compound units - M30 motor		
4	RB-200-MA	Handrührwerk - 200 Ltr. Gebinde - M40 Motor Hand agitator - 200 ltr. compound units - M40 motor		
Luftmotoren / Air motors				
	RB-M10	M10 - 60 Watt - 2.200 U/min / 2.200 RPM		
	RB-M20	M20 - 120 Watt - 3.000 U/min / 3.000 RPM		
5	RB-M30	M30 - 190 Watt - 2.500 U/min / 2.500 RPM		
	RB-M40	M40 - 300 Watt - 2.100 U/min / 2.100 RPM		
	RB-M50	M50 - 370 Watt - 1.420 U/min / 1.420 RPM		
Rührflügel / Mixing propeller				
6a	RFD80	Rührflügel - Edelstahl / Propeller - stainless steel - Ø80 - M8		
	RFD150	Rührflügel - Edelstahl / Propeller - stainless steel - Ø150 - M8		
6b	RFD150-3	Rührflügel Ø150 - Edelstahl - ohne Gewinde - mit Fixierschraube - Ø Loch 15 mm Propeller - Ø150 - stainless steel - without threading - with fixation - Ø hole 15 mm		
7	RFD85	Rührflügel - Edelstahl / Propeller - stainless steel - Ø85		

# PRONA. AGITATOR. LIFTS.

### Pneumatische Rührwerke

- Erhältlich auf Bodenplatte oder auf Fahrwagen
- Verfügbar mit oder ohne pneumatischem Lift

### Pneumatic agitators

- Available on fixed plate or on trolley
- With or without pneumatic lift



**1 BASE**

190 Watt  
0-3.000 U./Min. / RPM

**3 AIR-LIFT**

190 Watt  
0-3.000 U./Min. / RPM

**2 AIR-LIFT**

190 Watt  
0-3.000 U./Min. / RPM

**4 COVER**

20 Ltr. - Ø 310 mm  
Edelstahl  
Stainless steel



PRONA				
Pos.	Art.-Nr. Part-No.	Artikelbeschreibung Description	Listenpreis List price €/Stück €/piece	Netto-Stückpreis bei Net unit price for
<b>Auf Fahrwagen - ohne Lift / On trolley - without lift</b>				
1	RB-BA-T	Komplett auf Fahrwagen - max. 30 Ltr. Gebinde Complete on trolley - max 30. ltr. compound units		
<b>Auf Bodenplatte - mit Lift / On fixed plate - with lift</b>				
2	RB-BA-AIR	Komplett auf Bodenplatte - max. 30 Ltr. Gebinde Complete on fixed plate - max 30. ltr. compound units		
<b>Auf Fahrwagen - mit Lift / On trolley - with lift</b>				
3	RB-BA-AIR-T	Komplett auf Fahrwagen - max. 30 Ltr. Gebinde Complete on trolley - max 30. ltr. compound units		
<b>Deckeinheit / Cover unit</b>				
4	RB-COVER-20	Inkl. Rührwerk - 20 Ltr. Gebinde - Ø 310 mm - Edelstahl With agitator - 20 ltr. compound units - Ø 310 mm - stainless steel		

PRONA				
Pos.	Art.-Nr. Part-No.	Artikelbeschreibung Description	Listenpreis List price €/Stück €/piece	Netto-Stückpreis bei Net unit price for
<b>Auf Bodenplatte - ohne Lift / On fixed plate - without lift</b>				
1	RB-BA	Komplett auf Bodenplatte - max. 30 Ltr. Gebinde Complete on fixed plate - max 30. ltr. compound units		

# LOW PRESSURE PAINT SPRAY GUNS



**PRONA**

Pos.	Art.-Nr. Part-No.	Artikelbeschreibung Description	Listenpreis	Netto-Stückpreis bei	
			List price	Net unit price for	
			€/Stück		
			€/piece		

**R-210**

1	R-210P-xx	Luftpistole mit Düse / Air gun with tip 0.8/1.0/1.2/1.5/1.8/2.0/2.5 mm				
2	R-210P-N-xx	Düse & Nadel / Nozzle & needle 0.8/1.0/1.2/1.5/1.8/2.0/2.5 mm				
3	R-210P-C-G2P	Luftkappe / AirCap - G2P - 0.8/1.0/1.2 mm				
	R-210P-C-K2	Luftkappe / AirCap - K2 - 1.5/1.8 mm				
	R-210P-C-R2	Luftkappe / AirCap - R2 - 2.0 mm				
	R-210P-C-W2	Luftkappe / AirCap - W2 - 2.5 mm				
4	G-SET-R-210P	<b>Luftpistolen-Drucktank-Set</b> Drucktank 2 Ltr., Schlauchpaket 1/4" - 2,5 m, Luftpistole R-210P - 1.5 mm <b>Air gun pressure tank set</b> Pressure tank 2 ltr., hose set 1/4" - 2,5 m, air gun R-210P - 1.5 mm				

Model	R-210P-08	R-210P-10	R-210P-12	R-210P-15	R-210P-18	R-210P-20	R-210P-25
Luftbedarf Air consumption	560 l/min		330 l/min		360 l/min		
Material Durchfluss Fluid output	400 ml/min		500 ml/min	270 ml/min	330 ml/min	400 ml/min	500 ml/min
Gewicht Weight	536 g						
Anschlussgewinde Fluid inlet thread	3/8"						
Luftanschluss Air inlet thread	1/4"						

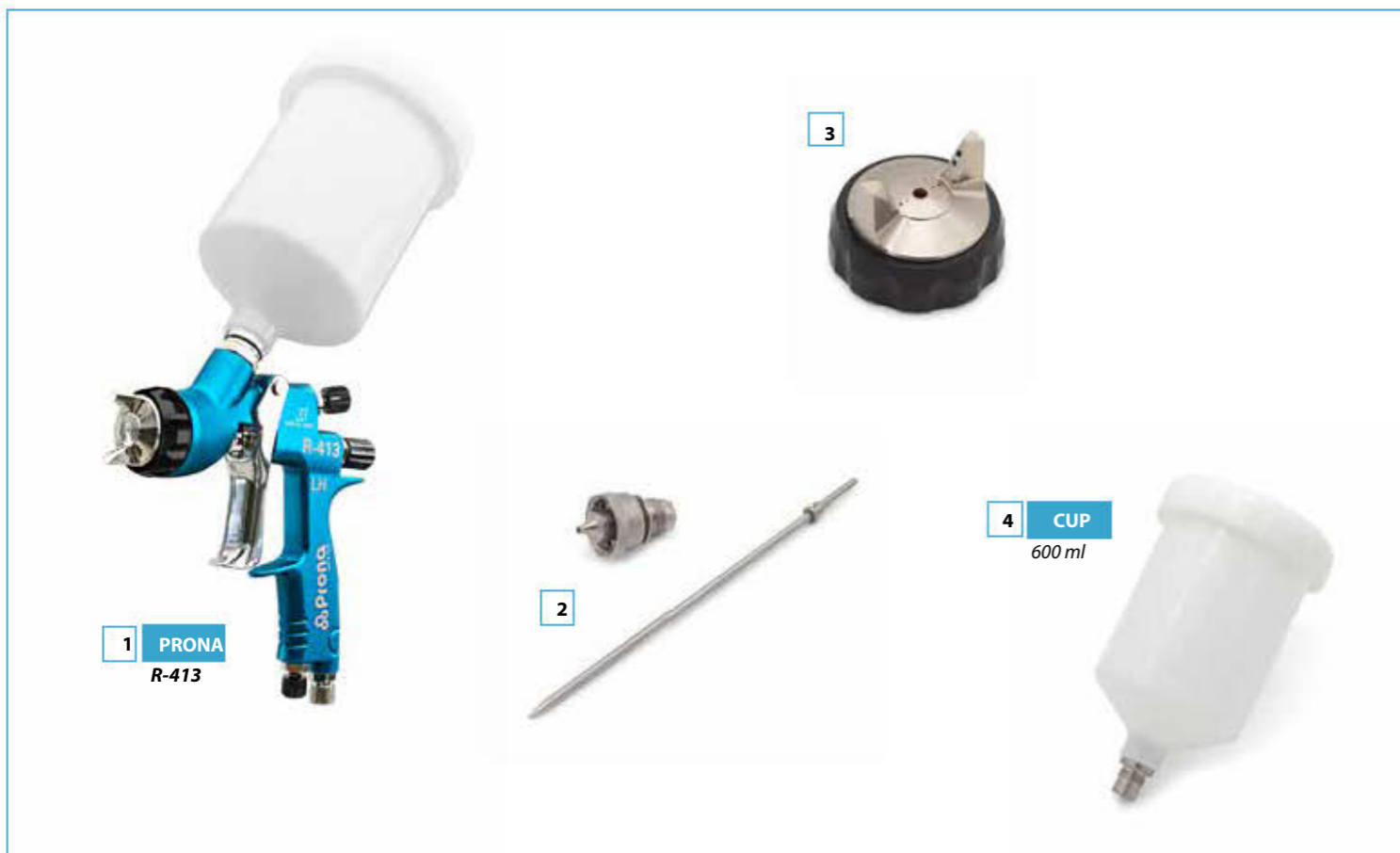

**PRONA**

Pos.	Art.-Nr. Part-No.	Artikelbeschreibung Description	Listenpreis List price	Netto-Stückpreis bei Net unit price for
			€/Stück €/piece	

**R-413**

1	R-413G-xx	Luftpistole mit Düse / Air gun with tip 1.2/1.3/1.4/1.5/1.6/1.8/2.0/2.5 mm		
2	R-413G-N-xx	Düse & Nadel / Nozzle & needle 1.2/1.3/1.4/1.5/1.6/1.8/2.0/2.5 mm		
3	R-413G-C-LV2	Luftkappe / AirCap - LV2 - 1.2/1.3/1.4/1.5/1.6/1.8/2.0 mm		
	R-413G-C-W2	Luftkappe / AirCap - W2 - 2.5 mm		
4	CUP-M16-QUICK	Fließbecher mit Schnellkupplung / Gravity cup with quick coupling M16x1.5 (M) - 600 ml		
	R-413G-SET	Reparatur-Set / Fixing-Set		

Model	R-413G-12	R-413G-13	R-413G-14	R-413G-15	R-413G-16	R-413G-18	R-413G-20	R-413G-25
Luftbedarf Air consumption	320 l/min							360 l/min
Material Durchfluss Fluid output	160 ml/min	180 ml/min	215 ml/min	270 ml/min	275 ml/min	330 ml/min	410 ml/min	510 ml/min
Gewicht Weight	464 g							
Anschlussgewinde Fluid inlet thread	M16x1.5							
Luftanschluss Air inlet thread	1/4"							

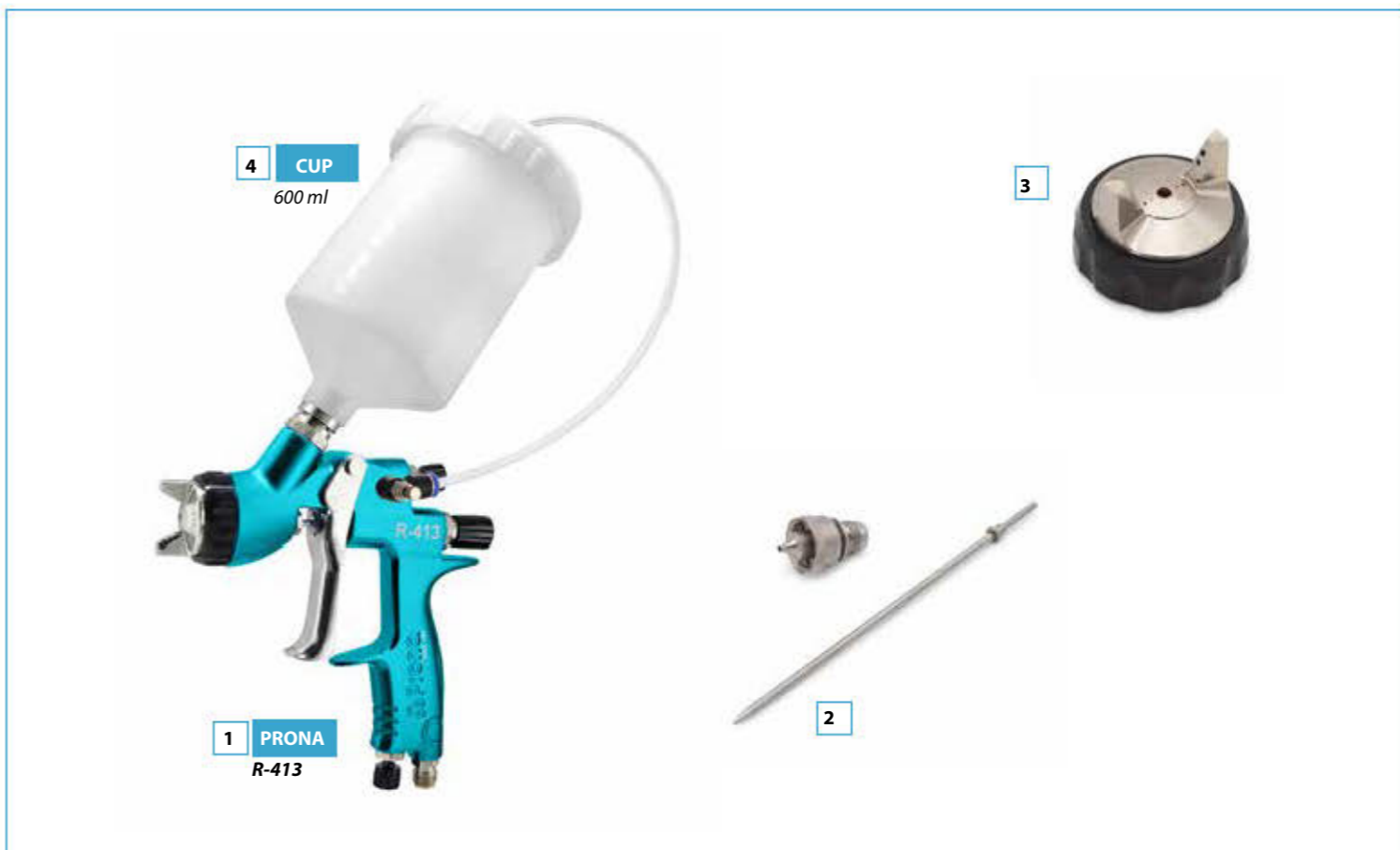

**PRONA**

Pos.	Art.-Nr. Part-No.	Artikelbeschreibung Description	Listenpreis List price	Netto-Stückpreis bei Net unit price for
			€/Stück €/piece	

**R-413**

1	R-413G-IP-xx	Luftpistole mit Düse und Druckbecher / Air gun with tip and pressure assisted cup 1.2/1.3/1.4/1.5/1.6/1.8/2.0/2.5 mm		
2	R-413G-N-xx	Düse & Nadel / Nozzle & needle 1.2/1.3/1.4/1.5/1.6/1.8/2.0/2.5 mm		
3	R-413G-C-LV2	Luftkappe / AirCap - LV2 - 1.2/1.3/1.4/1.5/1.6/1.8/2.0 mm		
	R-413G-C-W2	Luftkappe / AirCap - W2 - 2.5 mm		
4	RC-6M-P	Druckbecher / Pressure assisted cup M16x1.5 (M) - 600 ml		
	R-413G-SET	Reparatur-Set / Fixing-Set		

Model	R-413G-IP-12	R-413G-IP-13	R-413G-IP-14	R-413G-IP-15	R-413G-IP-16	R-413G-IP-18	R-413G-IP-20	R-413G-IP-25
Luftbedarf Air consumption	320 l/min							360 l/min
Material Durchfluss Fluid output	160 ml/min	180 ml/min	215 ml/min	270 ml/min	275 ml/min	330 ml/min	410 ml/min	510 ml/min
Gewicht Weight	517 g							
Anschlussgewinde Fluid inlet thread	M16x1.5							
Luftanschluss Air inlet thread	1/4"							



**PRONA**

Pos.	Art.-Nr. Part-No.	Artikelbeschreibung Description	Listenpreis List price	Netto-Stückpreis bei Net unit price for
			€/Stück €/piece	

**RA-101**

1	RA-101-xx	Pistole mit Düse / Gun with tip - 0.8/1.0/1.3/1.5/1.8 mm		
2	RA-101-N-xx	Düse & Nadel / Nozzle & needle 0.8/1.0/1.3/1.5/1.8 mm		
3	RA-101-C-E2P	Luftkappe / AirCap - E2P - 0.8/1.0 mm		
	RA-101-C-H2	Luftkappe / AirCap - H2 - 1.3/1.5 mm		
	RA-101-C-N2	Luftkappe / AirCap - N2 - 1.8 mm		

Model	RA-101-08	RA-101-10	RA-101-13	RA-101-15	RA-101-18
Luftbedarf Air consumption	270 l/min		260 l/min		190 l/min
Material Durchfluss Fluid output	150 ml/min	200 ml/min	250 ml/min	270 ml/min	310 ml/min
Gewicht Weight	475 g				
Anschlussgewinde Fluid inlet thread	1/4"				
Luftanschluss Air inlet thread	1/4"				

**PRONA**

Pos.	Art.-Nr. Part-No.	Artikelbeschreibung Description	Listenpreis List price	Netto-Stückpreis bei Net unit price for
			€/Stück €/piece	

**RA-200**

1	RA-200-xx	Pistole mit Düse / Gun with tip - 1.2/1.5/1.8/2.0/2.5 mm		
2	RA-200-N-xx	Düse & Nadel / Nozzle & needle 1.2/1.5/1.8/2.0/2.5 mm		
3	RA-200-C-G2P	Luftkappe / AirCap - G2P - 1.2 mm		
	RA-200-C-K2	Luftkappe / AirCap - K2 - 1.5/1.8 mm		
	RA-200-C-R2	Luftkappe / AirCap - R2 - 2.0 mm		
	RA-200-C-W2	Luftkappe / AirCap - W2 - 2.5 mm		

Model	RA-200-12	RA-200-15	RA-200-18	RA-200-20	RA-200-25
Luftbedarf Air consumption	560 l/min	330 l/min		360 l/min	
Material Durchfluss Fluid output	400 ml/min	270 ml/min	330 ml/min	400 ml/min	500 ml/min
Gewicht Weight	550 g				
Anschlussgewinde Fluid inlet thread	3/8"				
Luftanschluss Air inlet thread	1/4"				

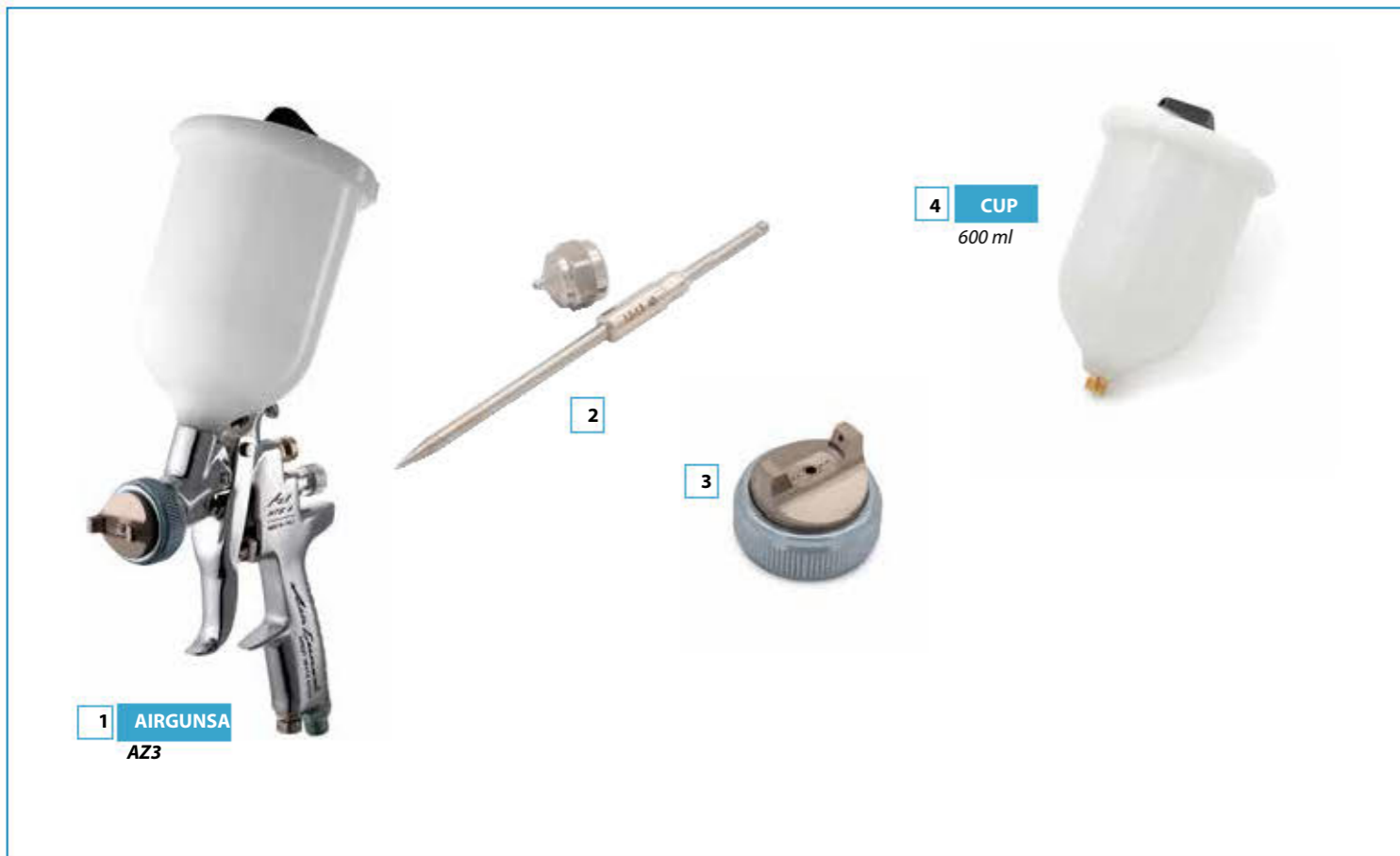

**AIRGUNSA**

Pos.	Art.-Nr. Part-No.	Artikelbeschreibung Description	Listenpreis List price	Netto-Stückpreis bei Net unit price for
			€/Stück €/piece	

**AZ3**

1	W0SPG81AGxxC	Luftpistole mit Düse / Air gun with tip 1.0/1.3/1.5/1.8/2.0/2.5/2.8/3.0/3.5 mm		
2	W201013xx	Düse & Nadel / Nozzle & needle 1.0/1.3/1.5/1.8/2.0/2.5/2.8/3.0/3.5 mm		
3	W2CAP80AG15	Luftkappe / AirCap - 1.0/1.3/1.5 mm		
	W2CAP80AG18	Luftkappe / AirCap - 1.8/2.0 mm		
	W2CAP80AG25	Luftkappe / AirCap - 2.5 mm		
	W2CAP80AG30	Luftkappe / AirCap - 2.8/3.0 mm		
	W2CAP80AG35	Luftkappe / AirCap - 3.5 mm		
4	W0012820100	Fließbecher / Gravity cup - PCG-6P 1/4" (M) - 600 ml		

Model	Ø 1.0	Ø 1.3	Ø 1.5	Ø 1.8	Ø 2.0	Ø 2.5	Ø 2.8	Ø 3.0	Ø 3.5
Luftbedarf Air consumption	200 l/min		215 l/min		280 l/min		300 l/min		
Material Durchfluss Fluid output	80 ml/min	140 ml/min	160 ml/min	250 ml/min	300 ml/min	450 ml/min	540 ml/min	560 ml/min	600 ml/min
Gewicht Weight	500 g								
Anschlussgewinde Fluid inlet thread	1/4"								
Luftanschluss Air inlet thread	1/4"								

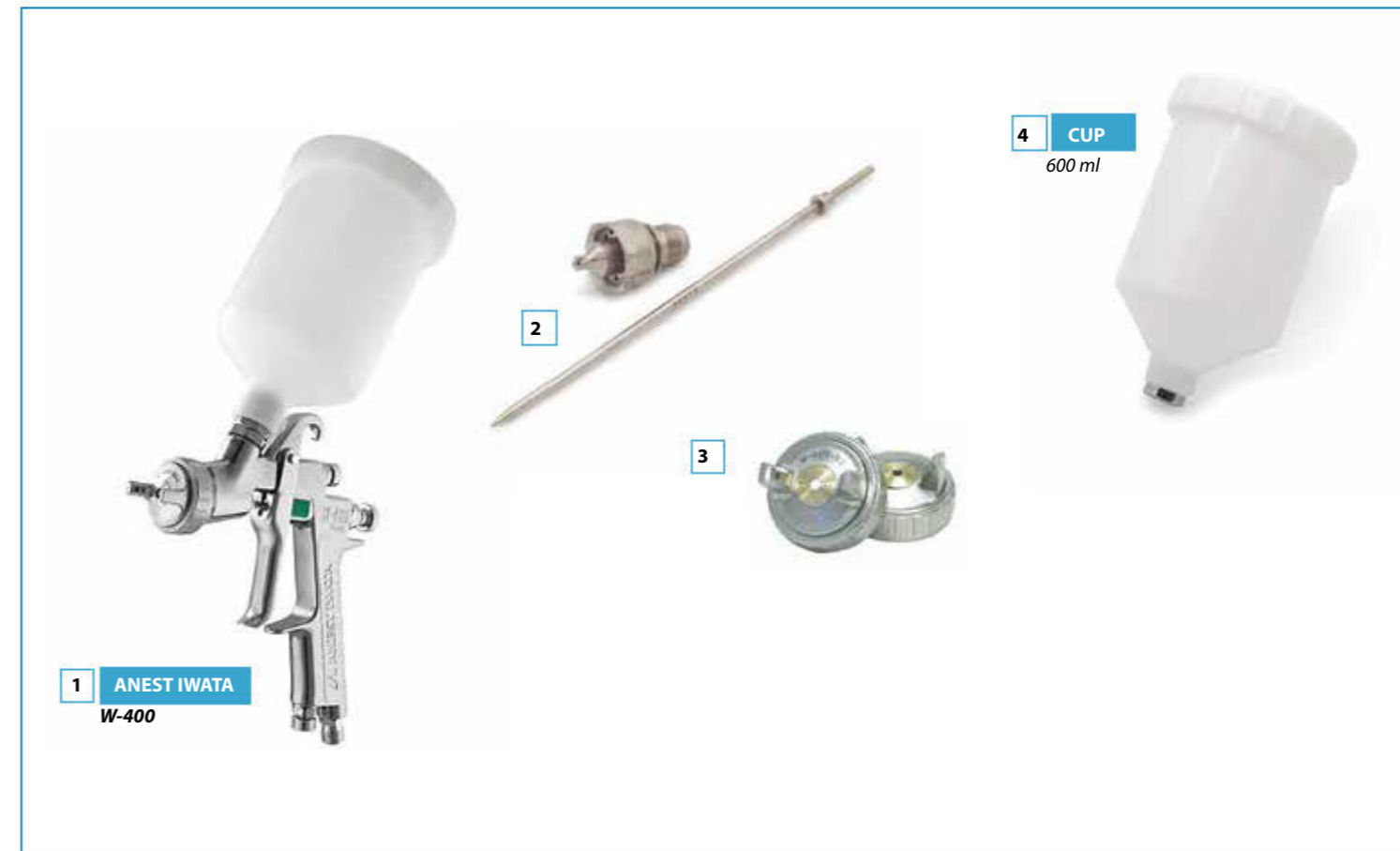

**ANEST IWATA**

Pos.	Art.-Nr. Part-No.	Artikelbeschreibung Description	Listenpreis List price	Netto-Stückpreis bei Net unit price for
			€/Stück €/piece	

**W-400**

1	1324140xx	Luftpistole mit Düse / Air gun with tip 0.8/1.0/1.2/1.3/1.4/1.6/1.8/2.0/2.5 mm		
2	938xx	Düse & Nadel / Nozzle & needle 0.8/1.0/1.2/1.3/1.4/1.6/1.8/2.0/2.5 mm		
3	93830610B	Luftkappe / AirCap - LV2 - 0.8/1.0/1.2/1.3/1.4/1.6 mm		
	93859611	Luftkappe / AirCap - LV1 - 1.8 mm		
	93814610B	Luftkappe / AirCap - R2 - 2.0 mm		
	93813610B	Luftkappe / AirCap - W1 - 2.5 mm		
4	14011001	Fließbecher / Gravity cup - PCG-6PE M16x1.5 (F) - 600 ml		

Model	Ø 0.8	Ø 1.0	Ø 1.2	Ø 1.3	Ø 1.4	Ø 1.6	Ø 1.8	Ø 2.0	Ø 2.5
Luftbedarf Air consumption	280 l/min					290 l/min		360 l/min	
Material Durchfluss Fluid output	60 ml/min	95 ml/min	100 ml/min	160 ml/min	210 ml/min	240 ml/min	320 ml/min	460 ml/min	360 ml/min
Gewicht Weight	380 g								
Anschlussgewinde Fluid inlet thread	M16x1.5								
Luftanschluss Air inlet thread	1/4"								





Pos.	Art.-Nr. Part-No.	Artikelbeschreibung Description	Listenpreis List price	Netto-Stückpreis bei Net unit price for
			€/Stück €/piece	
<b>Niederdruck-Tandemschlauch / Low pressure twin hose</b>				
1	ND-DS-2.5	6x8 mm - 2.5 m - 1/4" BSP - 15 bar Arbeitsdruck / working pressure		
	ND-DS-7.5	6x8 mm - 7.5 m - 1/4" BSP - 15 bar Arbeitsdruck / working pressure		
	ND-DS-10	6x8 mm - 10 m - 1/4" BSP - 15 bar Arbeitsdruck / working pressure		
	ND-DS-15	6x8 mm - 15 m - 1/4" BSP - 15 bar Arbeitsdruck / working pressure		

**Niederdruckschlauch - elektrisch leitfähig - lösemittelbeständig**  
**Low pressure hose - electroconductive - solvent resistant**

2	TPU20-6	6x10 mm - 20 bar Arbeitsdruck / working pressure (Rolle / Reel = 50 m)		
---	---------	--	--	--

**Luftschlauch / Air hose**

3	TPU20-6-AIR	6x10 mm - 20 bar Arbeitsdruck / working pressure (Rolle / Reel = 200 m)		
---	-------------	---	--	--



Pos.	Art.-Nr. Part-No.	Artikelbeschreibung Description	Listenpreis List price	Netto-Stückpreis bei Net unit price for
			€/Stück €/piece	

**Luft / Air**

1	JF-1/4	Luftregelventil / Air flow control valve - 1/4"		
2	LM-50	Luftregelventil mit Manometer - 1/4" - LowBudget Air flow control valve with gauge - 1/4" - LowBudget		
3	LT-331	Schnellkupplung / Quick coupling - 360° - 1/4" (F)		

**Fließbecher / Gravity cups - 600 ml**

4	CUP-M16-F	M16x1.5 (F)		
	CUP-M16-QUICK	M16x1.5 (M) - Schnellkupplung / Quick coupling		
	CUP-3/8-F	3/8" (F)		

**Filter**

5	35155-60-NY-LB	60 Maschen - Nylon / 60 mesh - Nylon		
	35155-60-SS-LB	60 Maschen - Edelstahl / 60 mesh - Stainless steel		
	35155-100-NY-LB	100 Maschen - Nylon / 100 mesh - Nylon		
	35155-100-SS-LB	100 Maschen - Edelstahl / 100 mesh - Stainless steel		

Art.-Nr. / Part-No.  
**EP2150-SET**

**ASM EP2150  
SprayPack "Airless"**

- Ansaugsystem mit Filter
- Schlauch: 1/4" - 15 m
- Pistole: ASM 500
- Halter & Düse: UniTip 515
- Suction system with filter
- Hose: 1/4" - 15 m
- Gun: ASM 500
- Base & tip: UniTip 515



1.8 Ltr./min.

0.021"

230 bar

Art.-Nr. / Part-No.  
**EP3150-SET**

**ASM EP3150  
SprayPack "Airless"**

- Ansaugsystem mit Filter
- Schlauch: 1/4" - 15 m
- Pistole: ASM 500
- Halter & Düse: UniTip 517
- Suction system with filter
- Hose: 1/4" - 15 m
- Gun: ASM 500
- Base & tip: UniTip 517v



3.6 Ltr./min.

0.031"

230 bar

Art.-Nr. / Part-No.  
**EP2550-SET**

**ASM EP2550  
SprayPack "Airless"**

- Ansaugsystem mit Filter
- Schlauch: 1/4" - 15 m
- Pistole: ASM 500
- Halter & Düse: UniTip 517
- Suction system with filter
- Hose: 1/4" - 15 m
- Gun: ASM 500
- Base & tip: UniTip 517



2.5 Ltr./min.

0.025"

230 bar

Art.-Nr. / Part-No.  
**EP3750-SET**

**ASM EP3750  
SprayPack "Airless"**

- Ansaugsystem mit Filter
- Schlauch: 3/8" - 15 m
- Schlauchpeitsche: 1/4" - 1.5 m
- Pistole: ASM 500
- Halter & Düsen: UniTip 517/535
- Suction system with filter
- Hose: 3/8" - 15 m
- Hose whip: 1/4" - 1.5 m
- Gun: ASM 500
- Base & tips: UniTip 517/535



4.5 Ltr./min.

0.037"

230 bar



Pos.	Art.-Nr. Part-No.	Artikelbeschreibung Description	Listenpreis List price	Netto-Stückpreis bei Net unit price for
			€/Stück €/piece	
1	500-G-UT	ASM 500 - 250 bar - 7/8" - 1/4" NPS - 2/4 Finger Inkl. Düsenhalter UniTip und Düse 517 / With base Uni Tip and tip 517		
2	670-G	ASM6700 Combo-Gun - 1/4" - 7/8"		
	670-F	ASM6700 Combo-Gun - 1/4" - 11/16"		
3	59-xxx	SUPER ZIP - Wendedüse / Reversible tip - 350 bar		
4	5901-F	SUPER ZIP - Düsenhalter / Tip base - 11/16"		
	5901-G	SUPER ZIP - Düsenhalter / Tip base - 7/8"		
	5907	SUPER ZIP - Dichtungssatz / Seal kit		
5	69-xxx	UniTip - Wendedüse / Reversible tip - 350 bar		
	69FF-xxx	UniTip - Wendedüse mit Vorzerstäuber / Reversible tip with preorifice - 350 bar		
6	6901-F	UniTip - Düsenhalter / Tip base - 11/16"		
	6901-G	UniTip - Düsenhalter / Tip base - 7/8"		
	6901-M1.0	UniTip - Düsenhalter / Tip base - M18x1.0		
	6901-M1.5	UniTip - Düsenhalter / Tip base - M18x1.5		
	6907	Dichtungssatz (5x) / Seal kit (5x)		



Düsenverlängerungen / Pole-extensions				
Pos.	Art.-Nr. Part-No.	Artikelbeschreibung Description	Listenpreis List price	Netto-Stückpreis bei Net unit price for
			€/Stück €/piece	
1	32-150-F	15 cm - 11/16" - incl. Adapter		
	32-150-G	15 cm - 7/8" - incl. Adapter		
	32-300-F	30 cm - 11/16" - incl. Adapter		
	32-300-G	30 cm - 7/8" - incl. Adapter		
	32-450-F	45 cm - 11/16" - incl. Adapter		
	32-450-G	45 cm - 7/8" - incl. Adapter		
	32-600-F	60 cm - 11/16" - incl. Adapter		
	32-600-G	60 cm - 7/8" - incl. Adapter		
2	32-1000	Verlängerung / Maxi Pole only - 1 m		
	32-1000-F	Mit Kniegelenk / With anglehead - 1 m - 11/16"		
	32-1000-G	Mit Kniegelenk / With anglehead - 1 m - 7/8"		
3	32-7506-F	Kniegelenk / Anglehead - 11/16"		
	32-7506-G	Kniegelenk / Anglehead - 7/8"		
4	32-7551-F	Adapter für Pistole / Adapter for gun - 11/16"		
	32-7551-G	Adapter für Pistole / Adapter for gun - 7/8"		
5	32-3430-F	Adapter für Düsenhalter / Adapter for tip base - 11/16"		
	32-3430-G	Adapter für Düsenhalter / Adapter for tip base - 7/8"		

ASM Roller				
6	770900F-M	Rollervorsatz kpl. / Roller unit cpl. - 9" (GR244271)		
7	7722	Walze fein / Cover smooth - 13 mm (GR186944)		
	7723	Walze mittel / Cover medium - 19 mm (GR186945)		

Art.-Nr. / Part-No.  
**GR17E667**

**GRACO MARK VII ProContractor SprayPack**

- Ansaugsystem mit Filter
  - Schlauch: 1/2" - 15 m
  - Schlauchpeitsche: 3/8" - 3.5 m
  - Pistole: HD Blue Texture
  - Halter & Düsen: HDA 531/541
- Suction system with filter
  - Hose: 1/2" - 15 m
  - Hose whip: 3/8" - 3.5 m
  - Gun: HD Blue Texture
  - Base & tips: HDA 531/541



SOLANGE DER VORRAT REICHT  
WHILE STOCKS LAST

Art.-Nr. / Part-No.  
**GR17E671**

**GRACO MARK X ProContractor SprayPack**

- Ansaugsystem mit Filter
  - Schlauch: 1/2" - 15 m
  - Schlauchpeitsche: 3/8" - 3.5 m
  - Pistole: HD Inline Texture
  - Halter & Düsen: HDA 531/541
- Suction system with filter
  - Hose: 1/2" - 15 m
  - Hose whip: 3/8" - 3.5 m
  - Gun: HD Inline Texture
  - Base & tips: HDA 531/541



SOLANGE DER VORRAT REICHT  
WHILE STOCKS LAST



SOLANGE DER VORRAT REICHT  
WHILE STOCKS LAST

Art.-Nr. / Part-No.  
**GR289587**

**GRACO**

Sackpresse für Materialbehälter  
Bag press for material hopper



SOLANGE DER VORRAT REICHT  
WHILE STOCKS LAST

Art.-Nr. / Part-No.  
**GR287987**

**GRACO**

Materialbehälter 90 Ltr.  
Material hopper 90 ltr.

Art.-Nr. / Part-No.  
**GR17N226-1**

**GRACO FTXpress**

- 250 bar
- 7/8"
- 1/4" NPS
- 2/4 Finger



Inklusive  
2-Finger-Abzug  
Including  
2-finger-trigger

Art.-Nr. / Part-No.  
**GR17N226**

**Großverpackung** 10 Stück  
10 pieces **bulk packed**

Art.-Nr. / Part-No.  
**GR17P258**

**GRACO UltraMax**  
Cordless



Art.-Nr. / Part-No.  
**GR20B476**

**GRACO Ultra QuickShot**  
Cordless



GRACO				
Pos.	Art.-Nr. Part-No.	Artikelbeschreibung Description	Listenpreis List price	Netto-Stückpreis bei Net unit price for
<b>RAC V</b>				
1	GR262-xxx	Wendedüse / Reversible tip - 350 bar		
2	GR243161	Düsenhalter / Tip base - 7/8"		
	GR243263	Düsenhalter / Tip base - 11/16"		
<b>RAC X</b>				
3	LTX-xxx	Wendedüse blau - 350 bar - Größe .007-.013 Reversible tip blue - 350 bar - Size .007-.013		
	PAA-xxx	Wendedüse blau - 350 bar - Größe .015-.025 Reversible tip blue - 350 bar - Size .015-.025		
	HDA-xxx	Wendedüse braun - 350 bar - Größe .027-.071 Reversible tip brown - 350 bar - Size .027-.071		
	FFLP-xxx	Wendedüse grün mit Vorzerstäuber - 350 bar Reversible tip green with preorifice - 350 bar		
	LP-xxx	Wendedüse grün - Niederdruck Reversible tip green - low pressure		
4	GR246215	Düsenhalter / Tip base - 7/8"		
	GR246437	Düsenhalter / Tip base - 11/16"		



GRACO				
Pos.	Art.-Nr. Part-No.	Artikelbeschreibung Description	Listenpreis List price	Netto-Stückpreis bei Net unit price for
<b>Flachstrahl / Flat jet</b>				
1	GR269-xxx	Airless Contractor Düse bis Größe .035" Airless contractor tip up to size .035"		
2	GR163-xxx	Airless Standarddüse bis Größe .081" Airless standard tip up to size .081"		
3	GR163-xxx	Airless Feinspritzdüse mit Vorzerstäuber bis Größe .032" Airless fine finish tip with preorifice up to size .032"		
<b>GRACO JET-ROLLER</b>				
4	24V490	18 cm + CleanShot + RAC-X 515 (Pistole + Verlängerung + CleanShot + Düse) 18 cm + CleanShot + RAC-X 515 (gun + extension + CleanShot + tip)		
	24V491	25 cm + CleanShot + RAC-X 721 (Pistole + Verlängerung + CleanShot + Düse) 25 cm + CleanShot + RAC-X 721 (gun + extension + CleanShot + tip)		
5	287030	CleanShot - 7/8"		

Art.-Nr. / Part-No.  
**GRK60FH1**

**GRACO KING 60:1  
SprayPack**

- Ansaugsystem mit Filter
- Schlauch: 3/8" - 15 m
- Schlauchpeitsche: 1/4" - 1.8 m
- Pistole: XTR
- Halter & Düse: XHD 519

- Suction system with filter
- Hose: 3/8" - 15 m
- Hose whip: 1/4" - 1.8 m
- Gun: XTR
- Base & tip: XHD 519



Art.-Nr. / Part-No.  
**GRK70FH1**

**GRACO KING 70:1  
SprayPack**

- Ansaugsystem mit Filter
- Schlauch: 3/8" - 15 m
- Schlauchpeitsche: 1/4" - 1.8 m
- Pistole: XTR
- Halter & Düse: XHD 519

- Suction system with filter
- Hose: 3/8" - 15 m
- Hose whip: 1/4" - 1.8 m
- Gun: XTR
- Base & tip: XHD 519



**1** XTR520  
345 bar

**2** XTR720  
500 bar



**3** GRACO  
XHD  
500 bar

**4** GRACO  
7/8"  
11/16"

**GRACO**

Pos.	Art.-Nr. Part-No.	Artikelbeschreibung Description	Listenpreis List price	Netto-Stückpreis bei Net unit price for
<b>XTR 520 &amp; 720</b>				
1	XTR520	345 bar - 4 Finger - ohne Düse / without tip		
2	XTR720	500 bar - 4 Finger - ohne Düse / without tip		
<b>XHD</b>				
3	XHD-xxx	Wendedüse / Reversible tip - 500 bar		
4	XHD001	Düsenhalter / Tip base - 7/8"		
	XHD005	Düsenhalter / Tip base - 11/16"		



Art.-Nr. / Part-No.  
**GR233500**

**GRACO TRITON 1:1 - 150**  
• 3/8"  
• 32 Ltr. / min.  
• Aluminium

Art.-Nr. / Part-No.  
**GR233501**

• Edelstahl Variante  
• *Stainless steel version*

Art.-Nr. / Part-No.  
**GR234915**

**GRACO TRITON 1:1 - 308**  
3/8" - 7.6 Ltr./min. - Aluminium

**SprayPack auf Fahrwagen**

- AC-Regler
- Ansaugsystem mit Filter
- Tandemschlauch 7.5 m
- AirPro Pistole 1.4 mm

**SprayPack on trolley**

- AC-regulator
- Suction system with filter
- Twin-hose 7.5 m
- AirPro gun 1.4 mm



Art.-Nr. / Part-No.  
**GRG15C09**

**GRACO MERKUR AIRCOMBI**  
15:1 - 25 cm<sup>3</sup> - 1.5 Ltr./min.

**SprayPack auf Fahrwagen**

- AC-Regler
- Ansaugsystem mit HD-Filter
- Tandemschlauch 7.5 m
- PerformAA 15 Pistole & Düse

**SprayPack on trolley**

- AC-regulator
- Suction system with HP-filter
- Twin-hose 7.5 m
- PerformAA 15 gun & tip

Art.-Nr. / Part-No.  
**GRG30C25**

**GRACO MERKUR AIRCOMBI**  
30:1 - 25 cm<sup>3</sup> - 1.5 Ltr./min.

**SprayPack auf Fahrwagen**

- AC-Regler
- Ansaugsystem mit HD-Filter
- Tandemschlauch 7.5 m
- PerformAA 50 Pistole & Düse

**SprayPack on trolley**

- AC-regulator
- Suction system with HP-filter
- Twin-hose 7.5 m
- PerformAA 50 gun & tip

Art.-Nr. / Part-No.  
**GRG30C67**

**GRACO MERKUR AIRCOMBI**  
30:1 - 75 cm<sup>3</sup> - 4.5 Ltr./min.

**SprayPack auf Fahrwagen**

- AC-Regler
- Ansaugsystem mit HD-Filter
- Tandemschlauch 7.5 m
- PerformAA 50 Pistole & Düse

**SprayPack on trolley**

- AC-regulator
- Suction system with HP-filter
- Twin-hose 7.5 m
- PerformAA 50 gun & tip

Art.-Nr. / Part-No.  
**GRG36C09**

**GRACO MERKUR AIRCOMBI**  
36:1 - 100 cm<sup>3</sup> - 6.0 Ltr./min.

**SprayPack auf Fahrwagen**

- AC-Regler
- Ansaugsystem mit HD-Filter
- Tandemschlauch 7.5 m
- PerformAA 50 Pistole & Düse

**SprayPack on trolley**

- AC-regulator
- Suction system with HP-filter
- Twin-hose 7.5 m
- PerformAA 50 gun & tip





Art.-Nr. / Part-No.  
**GR26B512**

**GRACO PerformAA 50**

- Pistole mit Drehgelenk
- Luftkappe (WL)
- Düse AXM 413
- Gun with swivel
- AirCap (WL)
- Tip AXM 413



Art.-Nr. / Part-No.  
**GR26B518**

**GRACO PerformAA 50**

- Pistole mit Drehgelenk
- Wendedüsensystem LTX413
- Gun with swivel
- Reversible tip system LTX413



Art.-Nr. / Part-No.  
**GR-AAM-xxx**  
Standard

**GRACO AAM**  
AirCombi Düse / Tip



Art.-Nr. / Part-No.  
**GR-AAF-xxx**  
Fine Finish

**GRACO AAF**  
Mit Vorzerstäuber  
With preorifice

**GR-AXM-xxx**  
Standard

**GRACO AXM**  
AirCombi Düse / Tip



Art.-Nr. / Part-No.  
**GR-AXF-xxx**  
Fine Finish

**GRACO AXF**  
Mit Vorzerstäuber  
With preorifice

Art.-Nr. / Part-No.  
**GR-AEM-xxx**  
Standard

**GRACO AEM**  
E-Static



Art.-Nr. / Part-No.  
**GR-GG3-xxx**  
Standard

**GRACO GG3**  
E-Static







Art.-Nr. / Part-No.  
**W394155**  
**WAGNER GM4600**  
Ohne Luftkappe und Düse  
*Without AirCap and tip*



Art.-Nr. / Part-No.  
**W2313585**  
**WAGNER GM4700**  
Ohne Luftkappe und Düse  
*Without AirCap and tip*

Art.-Nr. / Part-No.  
**W231358x**  
**WAGNER GM4700**  
Mit Luftkappe ohne Düse  
*With AirCap without tip*  
Red..... W2313586  
Blue ..... W2313587



Art.-Nr. / Part-No.  
**W231349x**  
**WAGNER Luftkappe / AirCap**  
Red.....W2313494  
Blue .....W2313497



Art.-Nr. / Part-No.  
**W231572x**  
**WAGNER Cage filter (10x)**  
Weiß / *White* - 50 M.....W2315726  
Gelb / *Yellow* - 100 M.....W2315725  
Blau / *Blue* - 150 M.....W2315724  
Rot / *Red* - 200 M.....W2315723



Art.-Nr. / Part-No.  
**W379-xxx**  
**WAGNER ACF3000**  
250 bar



Art.-Nr. / Part-No.  
**W321-xxx**  
**WAGNER ACF3000 plus**  
250 bar - mit Vorzerstäuber  
*250 bar - with preorifice*



Art.-Nr. / Part-No.  
**W395-xxx**  
**WAGNER ACF5000**  
250 bar - E-Static



Art.-Nr. / Part-No.  
**W132-7xx**  
**WAGNER**  
250 bar - Rundstrahldüse  
*250 bar - Round jet tip*



Art.-Nr. / Part-No.  
**W1088-xxx**  
**WAGNER TIP**  
530 bar



Art.-Nr. / Part-No.  
**W1088001**  
**WAGNER**  
Düsenhalter - 11/16"  
*Tip base - 11/16"*



Art.-Nr. / Part-No.  
**WIWA0015016**

**WIWA 500 HD**

- 500 bar
- 11/16"
- 1/4" NPS



Art.-Nr. / Part-No.  
**WIWA0012092**

**WIWA 500 HD Front**

- 500 bar
- 11/16"
- 1/4" NPS



Art.-Nr. / Part-No.  
**KR135732200**

**KREMLIN Xcite +**

- 200 bar
- Luftkappe / AirCap VX24

Art.-Nr. / Part-No.  
**KR134xxxx2**

**KREMLIN**

AirCombi Düse mit Vorzerstäuber  
*AirCombi Tip with preorifice*



Art.-Nr. / Part-No.  
**KR134xxxx4**

**KREMLIN**

AirCombi Düse  
*AirCombi Tip*



Preis auf Anfrage  
Price on request

Preis auf Anfrage  
Price on request



Art.-Nr. / Part-No.

**G-DI-15AX-LCD**

15 Liter

**G-DI-30AX-LCD**

30 Liter

**G-DI-30AX-LCD**

60 Liter

**Geld sparen durch Lösemittel-Recycling!**

- Explosionsgeschützt / ATEX geprüft
- Zum Recyclen von entflammaren und nicht entflammaren Lösemitteln
- Ladekapazität: 15 / 30 / 60 Liter
- Stromspannung: 230 V - 50 Hz
- Elektrischer Anschluss: Einphasig & Erdung
- Elektrische Sicherung: II2G IIA T3 bis T2
- Dampfkondensator: Edelstahl – Luftgekühlt
- Kein Verkauf innerhalb Deutschlands

**Recover Solvent - Safe Money!**

- Explosion proof version / ATEX approved
- For recycling of flammable and not flammable solvents
- Loading capacity: 15 / 30 / 60 litres
- Voltage: 230 V - 50 Hz
- Electrical supply: single phase & earth
- Electrical protection: II2G IIA T3 to T2
- Vapour condenser: stainless steel – cooled by air
- No sales to Germany

**Dichtung / Gasket**

**15 Liter**

- Standard .....G-F359001
- Acetone .....G-F359002
- Universal .....G-F239004

**30 Liter**

- Standard .....G-F359006
- Acetone .....G-F359007
- Universal .....G-F239010

**60 Liter**

- Standard .....G-Fxxxxxxx
- Acetone .....G-Fxxxxxxx
- Universal .....G-Fxxxxxxx

Preis auf Anfrage  
Price on request

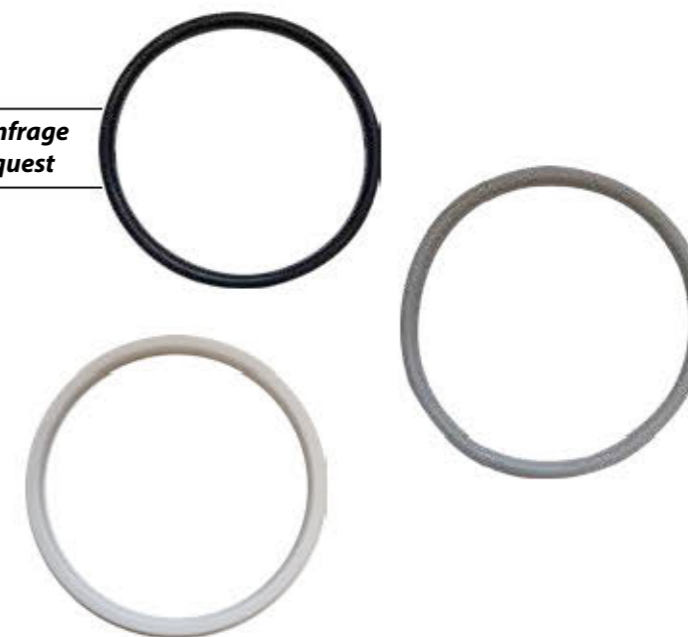

Art.-Nr. / Part-No.

**G-F38430x**

**Distiller bags**  
50 Stück / 50 pieces

- 15 Ltr.....G-F384306
- 30 Ltr.....G-F384307
- 60 Ltr.....G-F384308

Preis auf Anfrage  
Price on request

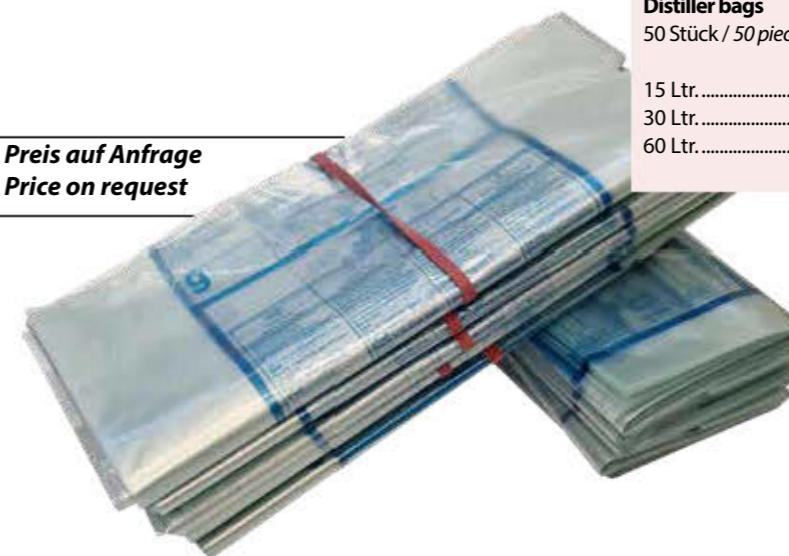





**Apeq Wiwa BV**  
Leemansstraat 13  
3364 AG Sliedrecht  
Netherlands

Tel.: +31 (0) 78 613 9610  
E-Mail: [info@apeqwiwa.nl](mailto:info@apeqwiwa.nl)  
Web: [www.apeqwiwa.nl](http://www.apeqwiwa.nl)